

# Viper Touch Broiler - Production User Manual





## 1 EU - Declaration of conformity

Manufacturer: SKOV A/S  
Address: Hedelund 4, DK-7870 Roslev, Denmark  
Telephone: +45 72 17 55 55

This declaration of conformity is issued under the sole responsibility of the manufacturer.

Product: Viper Touch series  
Type, model: Controller

EU directives:	2011/65/EU	RoHS Directive
	2014/30/EU	Electromagnetic Compatibility (EMC)
	2014/35/EU	Low Voltage Directive (LVD)

Standards: EN IEC 63000:2018  
EN IEC 61000-6-2:2019  
EN IEC 61000-6-4:2019  
EN IEC 62368-1:2024

We declare as manufacturer that the products meet the requirements of the listed directives and standards.

Location: Hedelund 4, DK-7870 Roslev

Date: 2025.12.08



Tommy Bak  
CTO











### **Product and Documentation Changes**

Big Dutchman reserves the right to change this document and the product herein described without further notice. In case of doubt, please contact Big Dutchman.

The date of change appears from the front and back pages.

### **Note**

- All rights belong to Big Dutchman. No part of this manual may be reproduced in any manner whatsoever without the expressed written permission of Big Dutchman in each case.
- All reasonable efforts have been made to ensure the accuracy of the information contained in this manual. Should any mistakes or imprecise information occur in spite of this, Big Dutchman would appreciate being notified thereof.
- Copyright by Big Dutchman.

<b>1</b>	<b>EU - Declaration of conformity</b>	<b>3</b>
<b>2</b>	<b>Guidelines</b>	<b>7</b>
<b>3</b>	<b>Product description</b>	<b>8</b>
<b>4</b>	<b>Operating instructions</b>	<b>11</b>
<b>4.1</b>	<b>Operation</b>	<b>11</b>
4.1.1	Selection of language	12
4.1.2	Searching for functions	12
<b>4.2</b>	 <b>Operation – for broilers</b>	<b>14</b>
<b>4.3</b>	 <b>Report</b>	<b>15</b>
<b>4.4</b>	 <b>Auxiliary</b>	<b>16</b>
<b>4.5</b>	 <b>Activity log</b>	<b>17</b>
<b>4.6</b>	 <b>Menu button</b>	<b>18</b>
4.6.1	 Pause functions	19
4.6.2	 Strategy	21
4.6.2.1	Setting curves	22
4.6.3	 Settings	23
4.6.3.1	System	23
4.6.3.1.1	Password	23
4.6.3.2	Alarms	25
4.6.3.2.1	Stopping an alarm signal	26
4.6.3.2.2	Power failure alarm	26
4.6.3.2.3	Alarm test	26
<b>5</b>	<b>Production</b>	<b>27</b>
<b>5.1</b>	<b>Batch</b>	<b>28</b>
<b>5.2</b>	<b>Weight</b>	<b>29</b>
5.2.1.1	Correction factor	31
5.2.1.2	Disconnect period	32
5.2.1.3	Search limits	33
<b>5.3</b>	<b>Feed</b>	<b>33</b>
5.3.1	Handling of feed in the system	33
5.3.2	Feed consumption	34
5.3.2.1	Manual distribution of feed before start	35
5.3.3	Naming of feed type	35
5.3.4	Feed control	35
5.3.4.1	Feed programs	35
5.3.4.2	Feed control - pan feeding	36
5.3.4.2.1	Time-controlled pan feeding	37
5.3.4.2.2	Time and amount controlled pan feeding	37
5.3.4.2.3	Time and amount controlled pan feeding with distribution	38
5.3.4.3	Feed control – chain feeding	40
5.3.4.3.1	Time-controlled chain feeding	40
5.3.4.4	Feed mixture	41
5.3.5	Feed weigher	42
<b>5.4</b>	<b>Water</b>	<b>43</b>
5.4.1	Water control	44
<b>5.5</b>	<b>Light</b>	<b>46</b>
5.5.1	Light program	46
5.5.2	Main light	47
5.5.3	Dawn and dusk	48
5.5.3.1	Dawn and dusk - advanced	48
5.5.4	Reducing main light	49

5.5.5	Flexible light settings.....	49
5.5.6	Follower light.....	50
5.5.7	Extra light.....	51
5.5.8	Inspection light.....	51
<b>5.6</b>	<b>Silo .....</b>	<b>52</b>
5.6.1	Change to different silo .....	53
5.6.2	Shared silo.....	55
5.6.3	Day silo – feed weighing.....	56
5.6.3.1	Filling of day silo .....	56
<b>5.7</b>	<b>24-hour clock.....</b>	<b>57</b>
<b>6</b>	<b>Alarm settings .....</b>	<b>58</b>
<b>6.1</b>	<b>Production .....</b>	<b>58</b>
6.1.1	Light alarms .....	58
6.1.2	Feed alarms.....	58
6.1.3	Water alarms.....	61
6.1.4	EggScan - egg counter .....	63
6.1.4.1	Water alarms.....	63
<b>6.2</b>	<b>Master/Client alarms.....</b>	<b>64</b>
<b>7</b>	<b>Maintenance instructions .....</b>	<b>65</b>
<b>7.1</b>	<b>Cleaning.....</b>	<b>65</b>
<b>7.2</b>	<b>Recycling/Disposal.....</b>	<b>65</b>

## 2 Guidelines

This user manual deals with the daily operation of the controller. The manual provides fundamental knowledge about the functions of the controller that is required to ensure optimum use of it.

The user manual only describes the production functions of the controller. You will find a general description of the operation and the climate functions of the controller in the appurtenant user manual.

If a function is not used, e.g., **24-hour clock**, it is not shown in the controller user menus. The manual may therefore contain sections that are not relevant to the specific setup of your controller. See also *Technical Manual* or contact service or your dealer, if required.

### 10" and 7" controller display

The displays shown in this manual are from a 10" controller display where the menu overview is shown to the left in the display. If you use a controller with a 7" display, the menus are shown in the middle of the display.

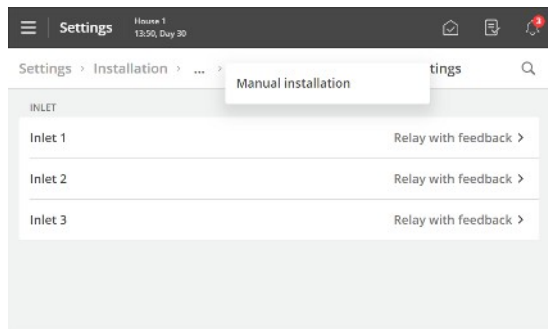

Using a 7" display you can press the menu headlines at the top of the display to go back step-by-step in the menus.

If more steps are available than what can be shown, you can press the 3 dots and select a menu from the appearing list.

### 3 Product description

Viper Touch is a series of one-house controllers specifically designed for poultry houses. The controller series includes several variants. Each of them meets the different requirements for climate and production control in each type of production and geographical, climatic conditions.

The controller is operated via a large touch display with graphical views of the ventilation status, icons and curves, among other things. The pages shown on the display are adapted to the different variants where the most relevant functions are easily accessible.

A wide range of functions such as 24-hour clock, light, water meter, and auxiliary sensor can be named by the user to suit the individual house and functions can be easily recognized in menus and alarms.

The controller has 2 LAN ports for connection to the network and also 2 USB ports.

Viper Touch Profi can regulate and monitor the climate and provides complete two-zone control that can regulate temperature, humidity, ventilation, cooling, humidification, and CO2 ventilation in 2 separate zones.

Viper Touch Profi is available in combination with different production variants:

- Broiler
- Breeder
- Layer

In addition, a variant is available for breeder production without climate functions.

The controller has 6 main pages, which are adapted to poultry production and a menu page. The pages contain selected functions and views relevant to the daily work.

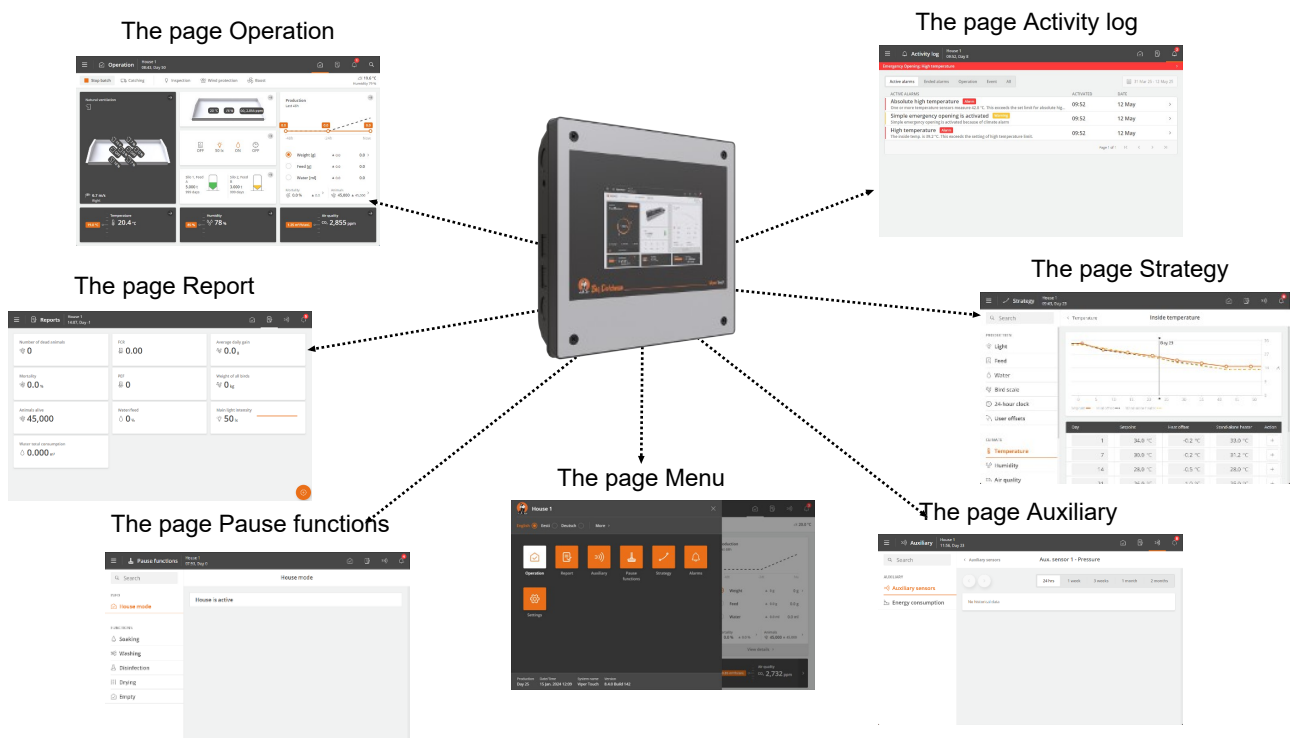
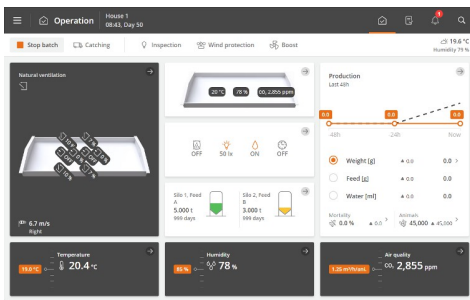

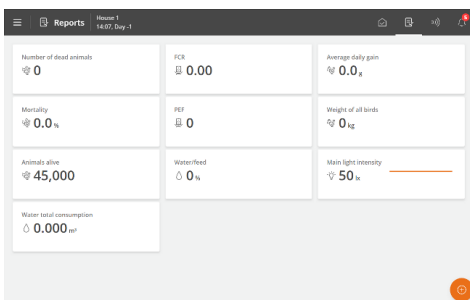

Figure 1: In addition, by selecting the different elements of the pages, there is access to underlying functions and data from the front pages.



 The page **Operation**

The page is the main page view where the functions that must be used for daily operation are gathered.



 The page **Report**

The page can be set up according to the user's wishes to contain cards with key values showing current data.

It can thus be used to collect values that must be read daily and collect data to be reported.

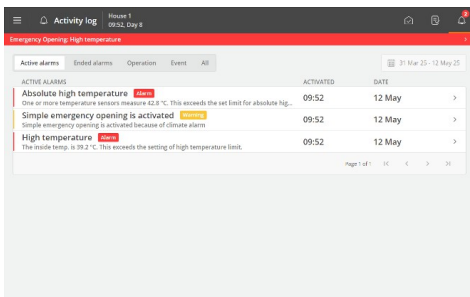

 The page **Activity log**

The page displays a log of all recorded alarms, operations of the controller and events.

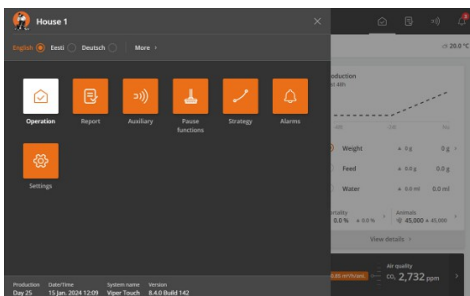

 Menu button

The button gives access to language selection and to a collection of shortcuts to the various pages.

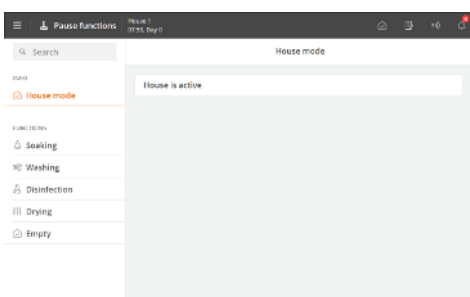

 The page **Pause functions**

The page gives access to functions designed partly to facilitate the activities you must carry out in the house to clean it and prepare it for the next batch and partly to ensure the air change and temperature in the house while it is empty.

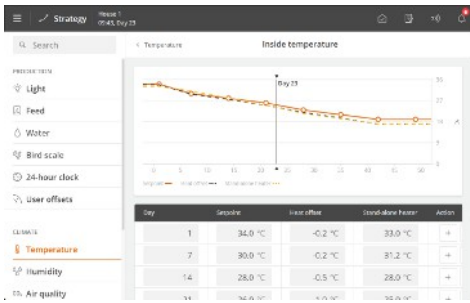

 The page **Strategy**

The page gives access to determination of the desired production strategy, which must be repeated from batch to batch.

These are, for example, program settings, references, and batch curves.

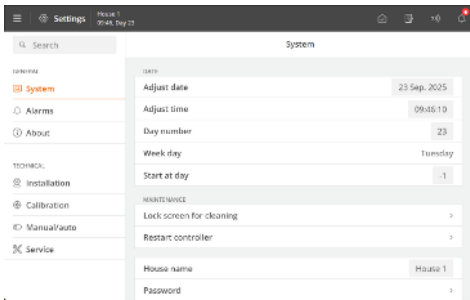

 The page **Settings**

The page provides access to general settings and alarm limits.

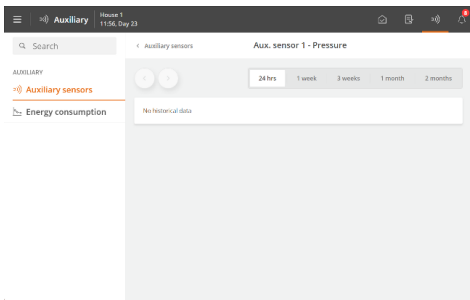

 The page **Auxiliary**

The page gives access to graphical displays of historical data from various types of additional equipment (auxiliary sensors and energy meters).

The page is only displayed if additional equipment is installed.

## 4 Operating instructions

### 4.1 Operation

Each page is composed by different types of cards that provide information about the operation and quick access to operation.

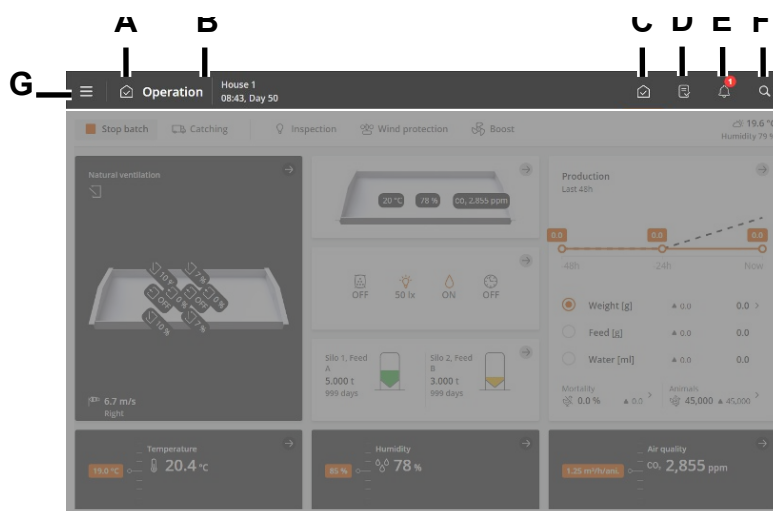

From the top bar of the page, there are shortcut buttons that allow you to switch between the main pages **Operation(C)**, **Reports(D)**, **Auxiliary(E)**, **Activity log(F)** and **Setting(G)**.

- A** The icon and name of the page.
- B** The house name, time, and possibly week and day number.
- C** The **Operation** page provides an overview and the ability to operate the functions most needed for your daily work.
- D** The **Reports** page shows the key values the user wants on the page.
- E** The **Auxiliary** page displays the consumption figures and auxiliary equipment status (if installed).
- F** The **Activity log** page displays active alarms and a complete log of operations, events, and alarms.
- G** The **Setting** page provide access to language selection (see section Selection of language [ ] 12]) and other pages: **Pause functions**, **Strategy** and **Setting**.



For additional operating instructions for the general functions of the controller, see the user manual for the climate controller.

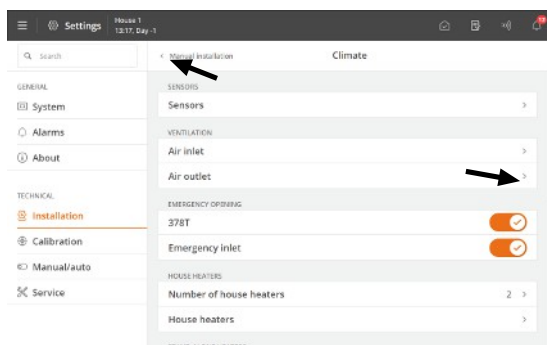

Navigation menus provide access to sub-menus.

➤ The right arrow displays a sub-menu.

⏪ The left arrow in the upper left corner allows you to take one step back in the menu.

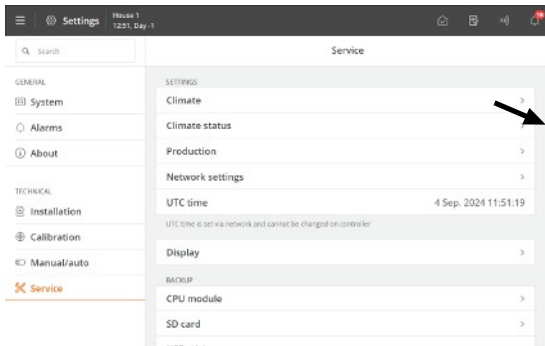

### Scroll

If the page is higher or wider than the display, you can scroll.

This is shown in the display as scroll bar.

Scroll by sliding your finger over the display.

7" display: Scroll by pressing the arrows or letting your finger slide across the display.

### Changing the settings

Values that can be changed are shown with a gray background.

Tap the value to open a keyboard.

Press **Save** or **Cancel** to close the keyboard.

### Shortcut to climate equipment settings

 **Climate equipment | Equipment status | Equipment**

Press an equipment icon in the house card to access a summary of the most important information and settings, and to put the equipment into manual mode.

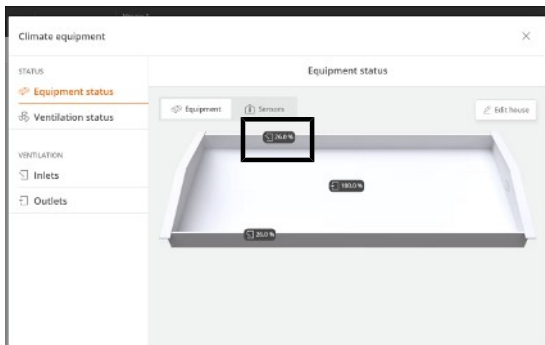

## 4.1.1 Selection of language

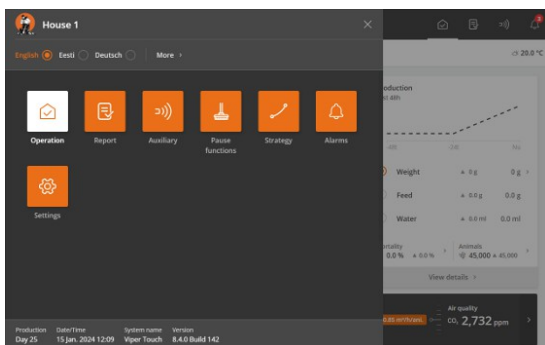

Press the  Menu button.

A dot indicates the selected language.

Press **More** if the desired language is not displayed.

Select the language from the list. Press **Save**.

Note that names of functions (such as 24-hour clocks, water meters, and programs that the user can name) do not follow the selected language.

The factory setting for the names is English.

## 4.1.2 Searching for functions

It is easy to find the individual controller functions.

Search is carried out across the following areas:

- Operating functions
- Strategy menu
- Pause function menu
- Settings (technical menus)
- Activity log

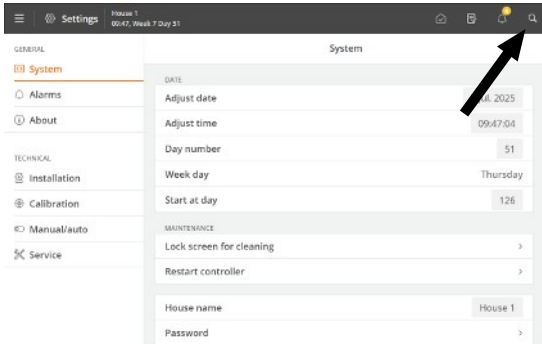

Open the search function by tapping the shortcut button on the top bar.

Enter at least 3 characters.

The search results appear below the search bar.

A path indicates the context of each search result. For example **General > Alarms > Climate**.

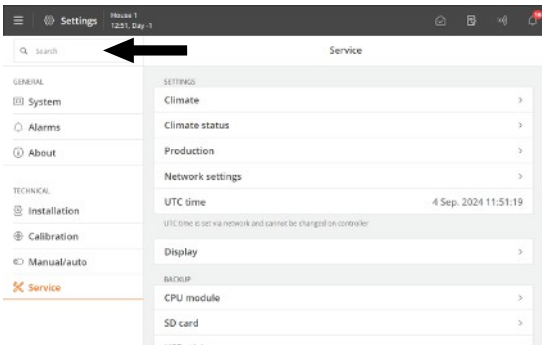

Use a filter to refine the search results.

Tap a search result to view it.

Press the cross in the upper right corner to close the search.

The most recent searches appear as shortcuts when the search function is reopened.

## 4.2 Operation – for broilers

The page has been adapted for broiler production. It contains views and settings relevant to the daily work of a broiler house.

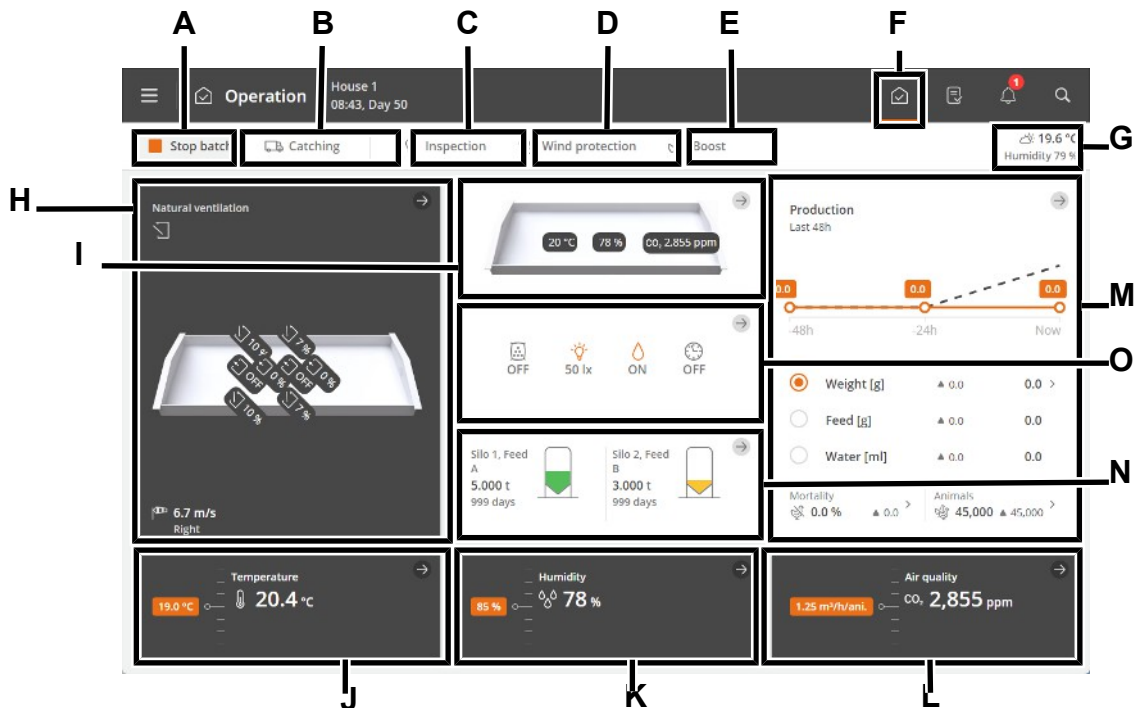

- A** The function button **Stop batch/Start batch**. See the section House status Active house - Empty house.
- B** The function button **Catching function**. The function is designed to alter the air change in the house in connection with all or some animals leaving the house. See the section Catching.
- C** The function button **Inspection** for manually activating the inspection light.
- D** Shortcut to **Wind protection** settings (Strategy menu) for natural ventilation.
- E** The function button **Boost** to manually activate boost. The function improves air quality by briefly increasing ventilation. See the section Ventilation boost.
- F** **Shortcut to the main page Operation.**
- G** View of outside temperature and outside humidity.
- H** Status view for climate control and access to the climate equipment menus and house card setup.  
The status view also provides a shortcut for manual control of the climate equipment. This is intended for situations where equipment must be stopped.
- I** The house card displays values for climate sensors and climate equipment. The values are displayed as whole numbers. In case of an error, a line appears instead and the value changes color to red.  
The house card provides access to status displays for climate control, menus for climate equipment, and house card configuration.
- J** Temperature settings. See the section Temperature.
- K** Humidity settings. See the section Humidity.
- L** The ventilation functions CO<sub>2</sub> and NH<sub>3</sub>.
- M** View of the development of key figures for animal weight, feed, and water consumption during the past 2 days. In addition, the view of calculated mortality and the current number of animals and shortcuts for recording the number of animals, the number of dead and moved animals.  
The view also provides a shortcut to details with information and settings options.
- N** Status view for silo content. The views provide a shortcut to recording of feed supplies and settings options for silo.

- O Status view for climate and production functions controlled by time programs. The view provide an overview of all programs and appurtenant settings, and for status and settings for production equipment.

### 4.3 Report

The user can set up the page to include the key values that give the desired overview of climate and production values.

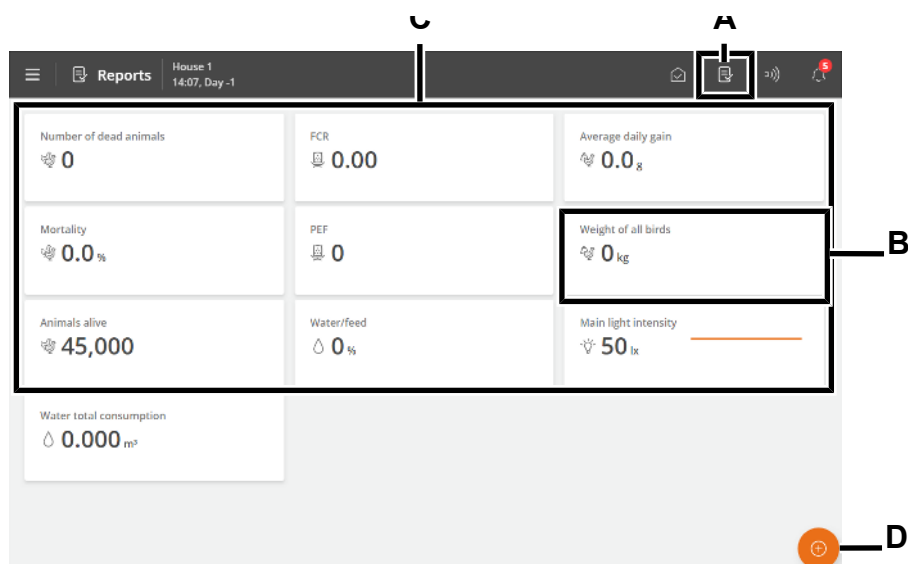

- A Shortcut to the **Reports** page.
- B Card with the key value. Each card can be set up to include up to 3 key values.
- C The page displays a series of cards with selected key values for, for example, history and current values.
- D Edit button. Gives access to choose between the desired key values.

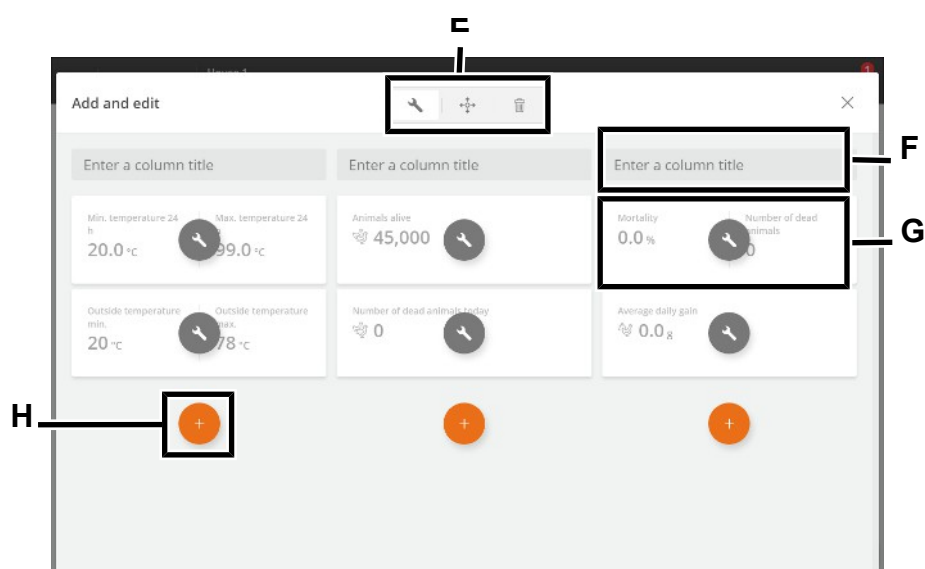



- E Tools for editing headlines or content on cards and moving or deleting cards. First, press a tool and then make the desired change.
- F Column header. Press to name.

- G** Card with the key value.  
Press to change the key value and set up its view.
- H** Tool for adding a new card in the column.  
Press to add a card and select the desired key value.

### Cards with several key values

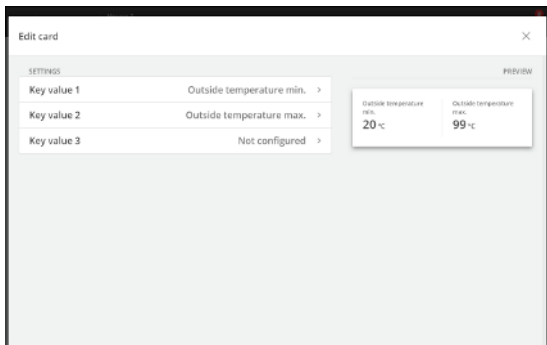
You can merge several cards to view up to 3 key values in one card.



- Press the editing tool .
- Press on the key value to be changed.
- Select Key value 2 and select the key value to be displayed.
- Select Key value 3, if required and select the key value to be displayed.
- To the right a preview of the card is shown.

## 4.4 Auxiliary

The page provides access to recordings from different types of equipment (auxiliary sensors and energy meters), which can be used for monitoring, as an example.

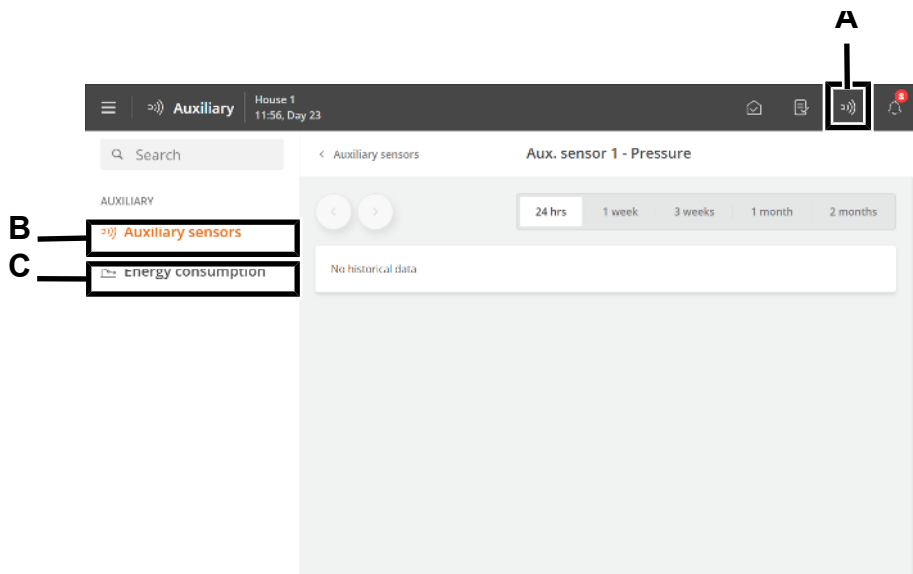

- A** Shortcut to the page **Auxiliary**.
- B** The **Auxiliary sensors** menu provides an overview of the controller recordings supplied by the auxiliary sensors in a graphical view.  
The auxiliary sensors do not influence the regulation.  
The controller records the content of CO<sub>2</sub>, NH<sub>3</sub>, O<sub>2</sub> in the air as well as humidity, pressure, and temperature. You can also connect air velocity and wind direction sensors that can measure the wind direction and wind velocity outside the house.  
The values measured by each sensor are viewed in intervals of 24 hours to 2 months.
- C** The menu **Energy consumption** shows the current consumption in W and total consumption in kWh. The menu content depends on the type and the setup of the controller.

## 4.5 Activity log

The Activity log page displays a log of alarms, operational changes, and events.

The most recent activity appears at the top. Up to 100 previous activities can be viewed on the underlying log pages.

The activity log tabs show the different activity categories.

Alarms are divided into active and terminated alarms.

Alarm status colors:

- Red – hard active alarm
- Yellow – soft active alarm (warning)
- Gray – deactivated alarm

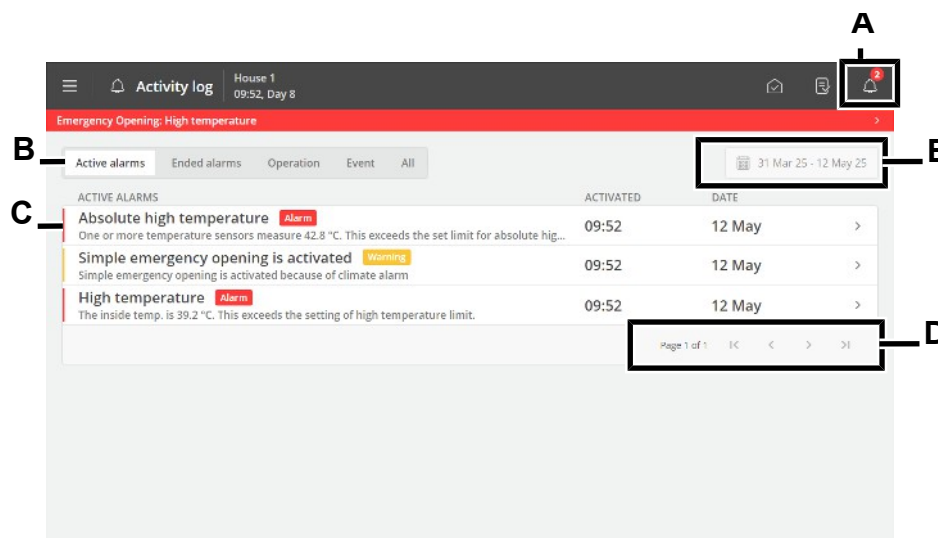

**A** Shortcut to the page **Activity log**.

The icon for the Activity log indicates the number of active alarms as long as an alarm situation has not ceased.

**B** Filtering options for the various types of activities:

**Active alarms:** displays alarms where the alarm situation is still present.

**Ended alarms:** displays alarms where the alarm situation has ceased.

**Operation:** shows the operation of the controller.

**Event:** This shows, for example, a controller restart and when someone has logged in via **Remote Access** (from the management application).

**All:** shows all types.

**C** Each line shows an activity.

Press the activity line to see details, such as when an alarm was activated and acknowledged. Also, when a value/setting was changed.

Press **Close** to close the details screen again.

**D** Page view in the activity log.

Switch one page at a time or switch to the first or last page.

**E** Filtering option for dates and periods.

Several alarms often follow each other because one defective function also affects other functions. For instance, a flap alarm can be followed by a temperature alarm as the controller cannot adjust the temperature correctly with a defective flap. Thus, the previous alarms allow you to follow an alarming course back in time to detect the error that caused the alarm.

See the description of alarms in the section Alarms [ ] 25].

## 4.6 Menu button

The menu button gives access to language selection and general settings pages.

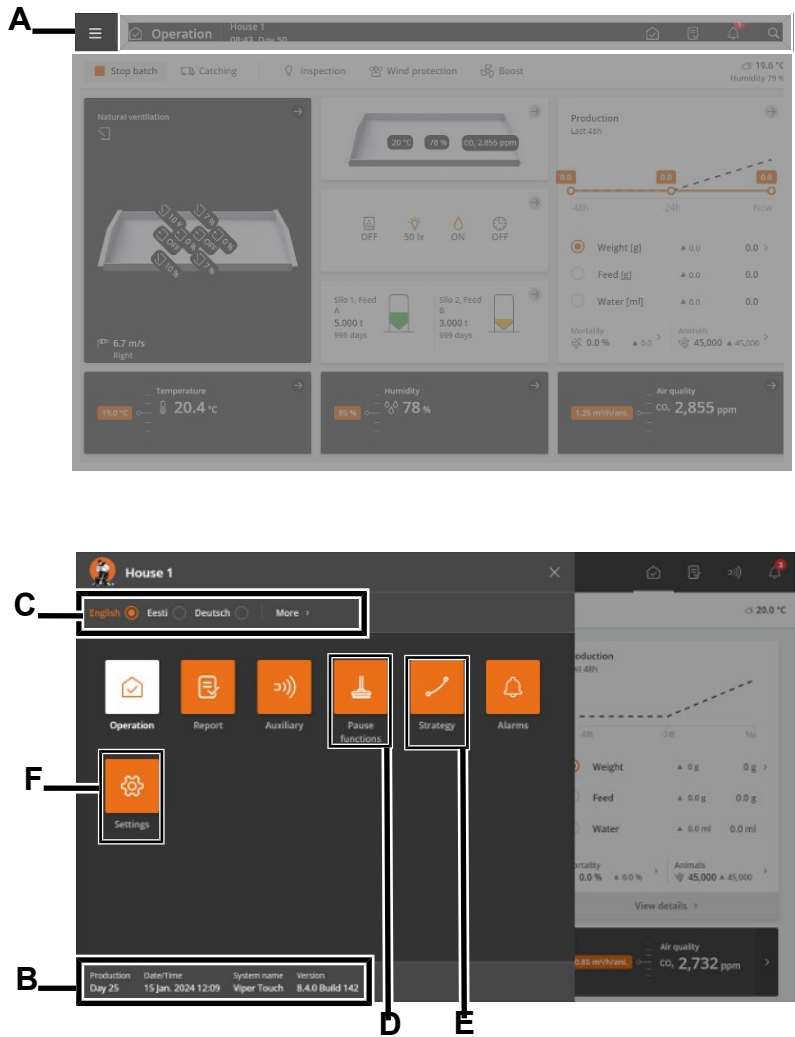

- A** Menu button
- B** Displaying house name, day number, time, week number, if required, variant name, and software version.
- C** Select language. Access other languages under **More**.  
Note that function names (such as 24-hour clocks, water meters), and programs the user can name are not translated into the selected language. The factory setting for the names is English.
- D** Shortcut to the page **Pause functions**.  
The page is designed partly to facilitate the activities you must carry out in the house to clean it and partly to ensure the air change and temperature in the house while it is empty.
- E** Shortcut to the page **Strategy**.  
The page provides access to the batch curves, which form the basis for controlling climate and production functions. See also the section Setting curves [ 22].
- F** Shortcut to the page **Settings**.  
The page provides access to the user settings for **House info**, **Alarm settings**, and **Password**. See the sections System [ 23], Alarms [ 25], and Password [ 23].

In addition, you have access to the technical menus used for setup and service. See the Technical Manual.

## 4.6.1 Pause functions

The page gives access to functions designed partly to facilitate the activities you must carry out in the house to clean it and partly to ensure the air change and temperature in the house while it is empty.

- Soaking
- Washing
- Disinfection
- Drying
- Empty

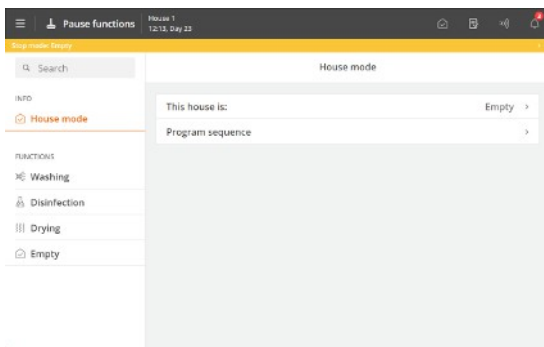

### State

The controller can only activate the functions when the house status is **Empty**.

Empty house status is indicated at the top of the page by a colored bar.

When the time of a function is up, the controller will again regulate according to the settings for **Empty**.

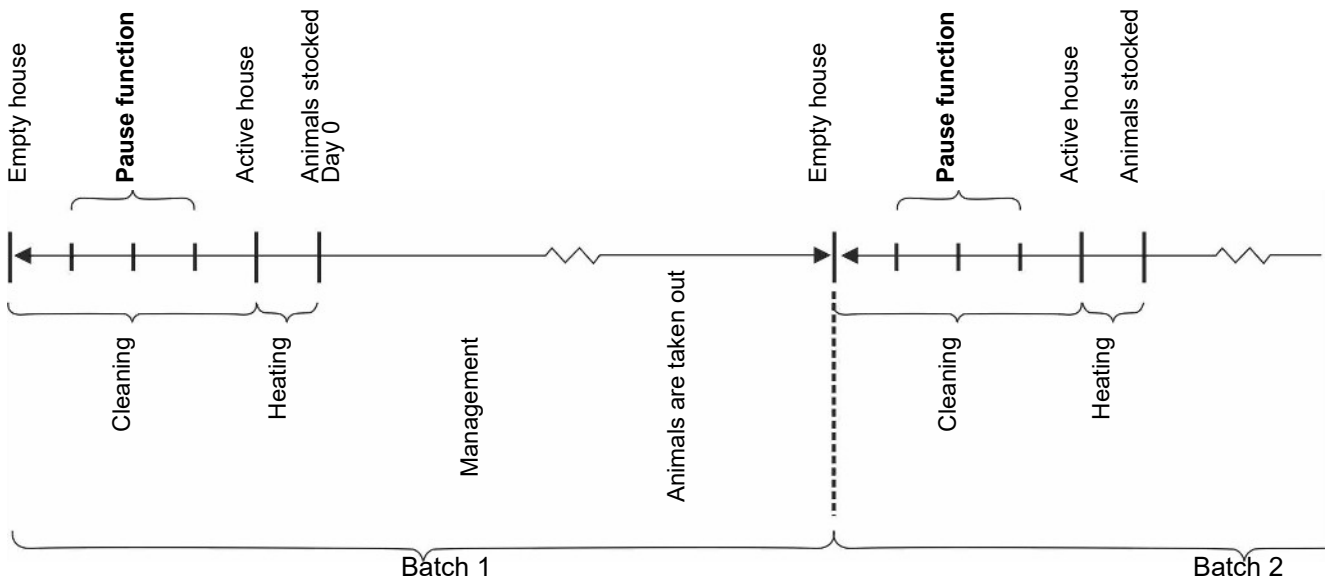

Figure 2: Setup example of Pause functions for batch production

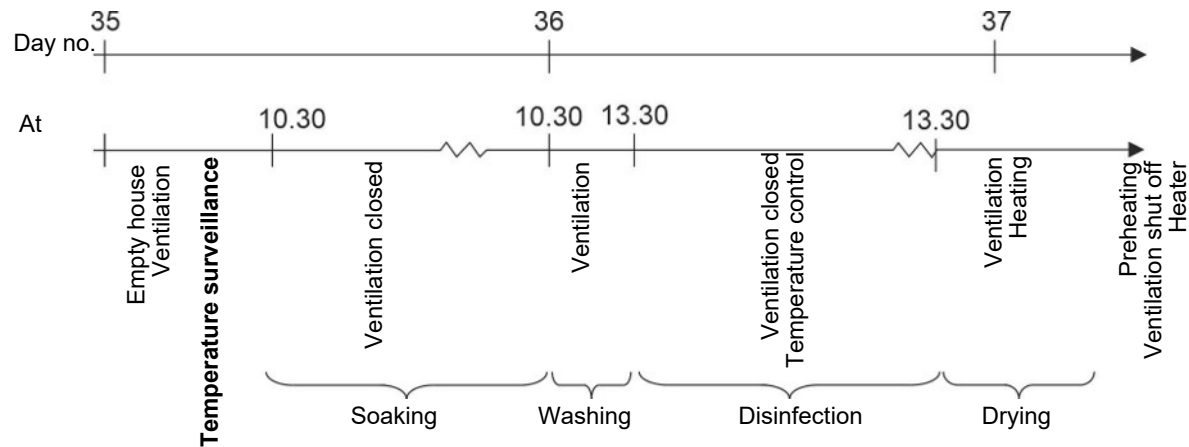
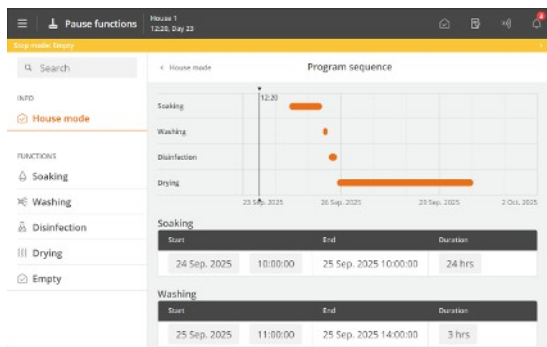

Figure 3: Sequence of functions



### Program sequence

You can set up each function to start at a specified time. It is thus possible to set an entire program sequence for the functions.

☰ Menu button | 📌 Pause functions | ⓘ Info | 🏠 House mode | 📅 Program sequence

<b>This house is:</b>	Function selection menu (only displayed when the house status is <b>Empty</b> ).
<b>Function remaining time</b>	When a function is activated, the set time counts down (only displayed when the house status is <b>Empty</b> ).
<b>Program sequence</b>	Menu for setting the start time and function duration (only displayed when the house status is <b>Empty</b> ).

Also see the section Between batches for a description of the various functions.

## 4.6.2 Strategy

The page provides access to the more constituent function settings that you typically do not need to change during a batch. The strategies are thus determined in light of the overall requirements for the production.

It is where batch curves for temperature and light are set up, sub-functions such as nozzle cleaning for cooling are selected, and limit value settings are made.

Changes to the strategy curves are grouped here and displayed as **User offset**.

See the relevant section below for a description of the various functions.

Together with other information, the curve settings form the basis of the controller's calculation of production regulation.

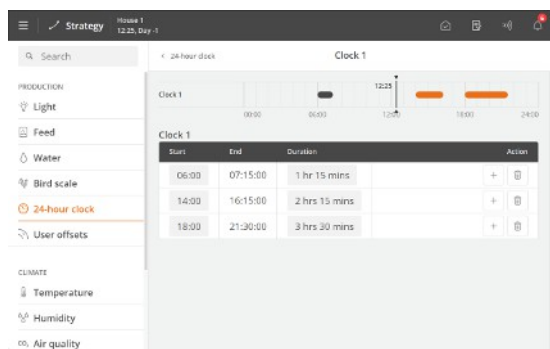

The controller can adjust automatically according to the animals' age.

When the controller is connected to a network with the management program BFN Fusion, curves can also be changed here.

Depending on the type and setup of the controller, different batch curves are available:

- Feed
- Water
- Weight
- Light

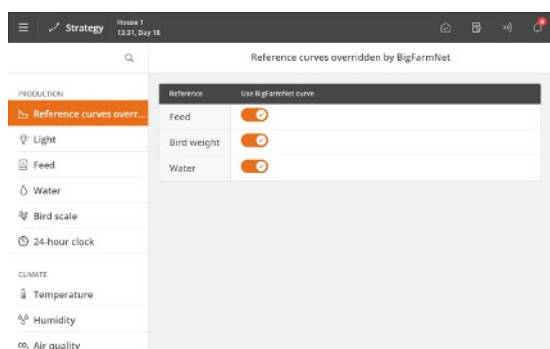

When curves are adjusted via BFN Fusion it appears in the menu.

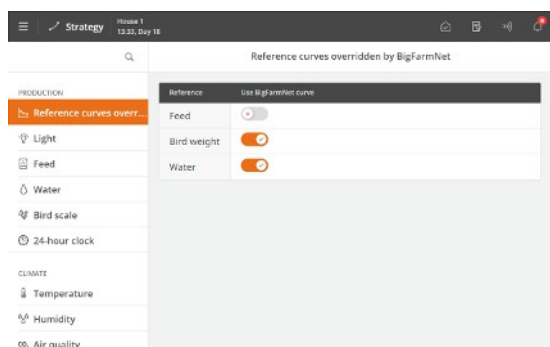

Select if the reference curve from BFN Fusion or the curve from the controller should be used.

### 4.6.2.1 Setting curves

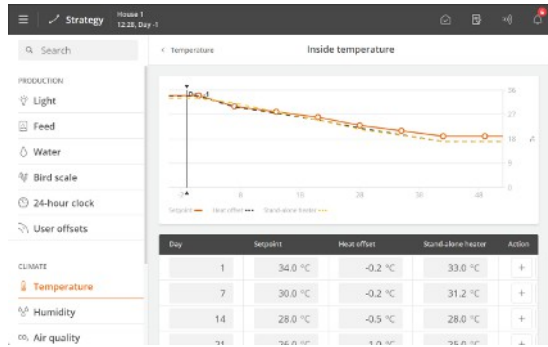

Menu button | Strategy

Set up for each curve:

- A day number for each of the required curve points.
- The desired value of the function for each curve point.

Press + to add the required number of curve points.

Typically, the last day number of the batch curve is set to match the expected production time.

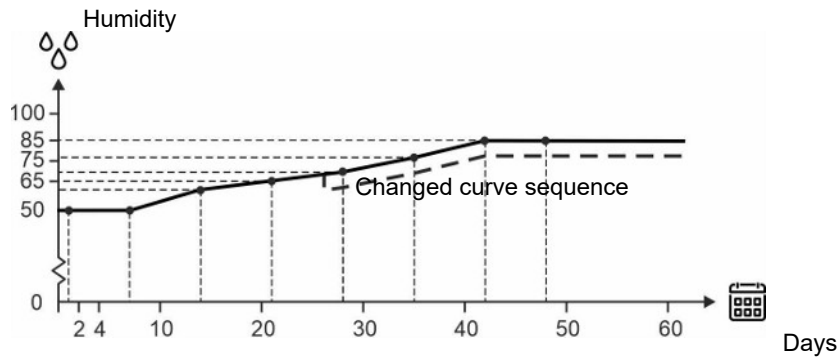

Figure 4: Curve for air humidity

It is generally the case for the curve functions that the controller automatically displaces the rest of a curve sequence in parallel when you change the associated setting during a batch.

## 4.6.3 Settings

The page provides access to general settings and alarm limits.

### 4.6.3.1 System

 Menu button |  Settings | General |  System

<b>Adjust date and time</b>	<p>Setting current date and time.</p> <p>Correct clock setting is important for several control functions and alarm recording. Thus, all controller programs use date, time, and day number.</p> <p>The clock will not stop in the event of a power failure.</p> <p><b>Summer and wintertime</b></p> <p>There is no automatic adaptation in summer and winter, as some animal types are very sensitive to changes in their circadian rhythm. If you want the controller to follow the local time for summer and winter, you must manually change the time setting by +/- 1 hour.</p>
<b>Day number</b>	<p>Select whether the day number should show the time since start (house status is active) or the actual age of the animals.</p> <p>When the actual age of the animals is required, the day number must be adjusted until it matches the life expectancy.</p> <p>At midnight, day number 1 counts for every day that passes.</p> <p>Please note that if the day number is changed during a batch, it will shift/destroy the historical data of the batch (feed consumption, etc.).</p> <p>The function <b>Day number</b> can also be used to preheat the house by setting a number of minus days.</p>
<b>Week day</b>	Viewing week day.
<b>Start on day</b>	<p>Setting the day on which the batch shall start.</p> <p>Day number can be set as low as -3 so the controller can control the preheating of the house before the animals are stocked.</p>
<b>House name</b>	<p>Setting house name.</p> <p>Each livestock house must have a unique name when the controller is integrated with a LAN network. The house name is transferred through the network, and the livestock house should be identifiable based on the name.</p> <p>Set up a plan for naming all controllers connected to the network.</p>
<b>Password</b>	<p>Decide whether the controller must be protected against unauthorized operation using passwords.</p> <p>See section Password [ ] 23].</p>

#### 4.6.3.1.1 Password

This section is only relevant to houses where the Password function is activated.

The controller can be protected against unauthorized operation using passwords.

In order to have access to changing a setting, a password must be entered that corresponds to the user level which the relevant function is found at (**Daily**, **Advanced** and **Service**).

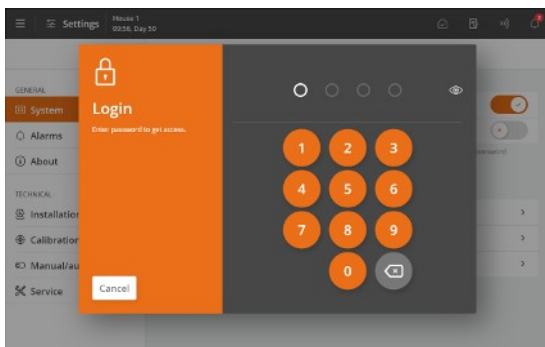

  **General | System** |  **Password** to access the activation of the function.

Enter a service password.

After entering the password, the controller can be operated at the corresponding user level. After 10 minutes without operation, the user is automatically logged out.



**Access limitation to operate the controller**

We recommend that you change the default passwords and subsequently change the password regularly.

To gain access to changing a password a valid password must first be entered.

  **General | System** |  **Password**.

User level	Gives access to	Factory-set code
Daily view (without login)	Entering the number of animals Fine-tuning of temperature, humidity, and air quality Manual climate control	
Daily	Daily: Changing set values	1111
Advanced	Daily + advanced: Changing curves and alarm settings Manual production control	2222
Service	Daily + advanced + service: Changing settings under Technical menu	3333



**Use password for technical menu only**

The controller requires only the service password, for the **Installation**, **Calibration** and **Service** menus.

**Forgotten password**

If an incorrect password is entered 3 times, the controller will display its MAC address and UTC date.

These must be provided when contacting the service partner who can assist with a new, temporary service access code. The password is specific to the individual controller and only valid on the day it is generated.

### 4.6.3.2 Alarms



Alarms only work when the status is Active house.

The only exceptions are alarm tests and alarms for CAN communication and temperature surveillance at **Empty**.

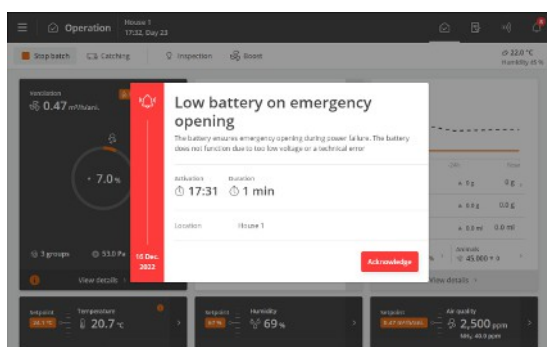

The controller will record the alarm type and time when an alarm occurs.

The information on the type of alarm will appear in a separate alarm window, together with a short description of the alarm situation.

Red: hard alarm

Yellow: soft alarm

Gray: deactivated alarm (alarm state ceased)

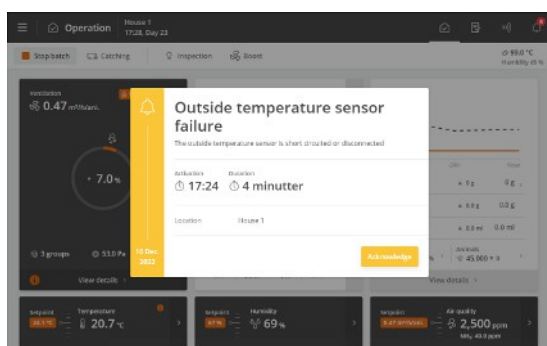

You can choose whether the alarm should be hard or soft for selected climate and production alarms.

**Hard alarm:** Red alarm pop-ups on the controller and generation through the connected alarm units, e.g., a horn. Only hard alarms trigger the alarm relay.

**Soft alarm:** Yellow pop-up alert on the house controller. Soft alarms generate a pop-up in the display.

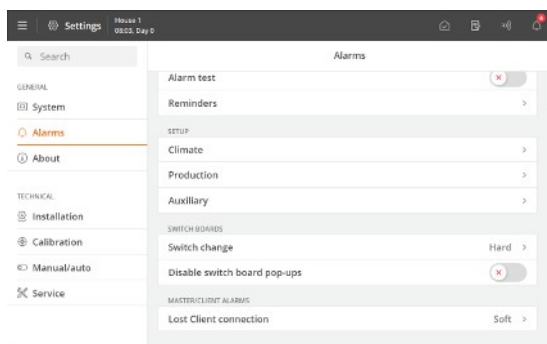

The controller will also trigger an alarm signal, which you can choose to maintain.

The alarm signal will thus continue to sound until you acknowledge the alarm. It also applies even if the situation that triggered the alarm has ceased.

Menu button | Settings | Alarms

**Alarms maintained:** Selecting whether the alarm signal should continue after the alarm condition has ceased.

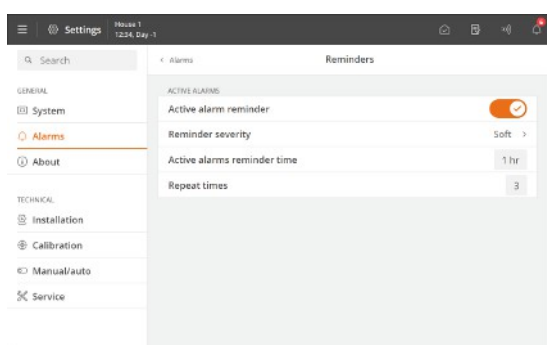

#### Reminder

The controller can remind you of an ongoing alarm once you have acknowledged a hard alarm. It should ensure that the cause of the alarm is handled.

Reminder settings:

**Active alarms reminder time:** Setting how long after the alarm, the reminder is to appear.

**Repeat times:** Setting how many times the reminder is to appear.

See section Climate for setting the alarm and alarm limits.

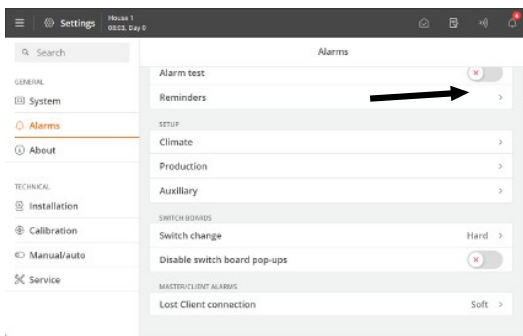

### Switch change

When the controller is connected to an override switch module, an alarm is available for changing the module's switch position.

Changes in the switch position are logged in the Aktivitet-sloggen.

#### 4.6.3.2.1 Stopping an alarm signal

The alarm window disappears, and the alarm signal stops when you acknowledge the alarm by pressing **Acknowledge**.

#### 4.6.3.2.2 Power failure alarm

The controller will always generate an alarm and activate emergency opening in the event of power failure.

#### 4.6.3.2.3 Alarm test

Regular alarm tests help to ensure that the alarms actually work when needed. Therefore you should test the alarms every week.

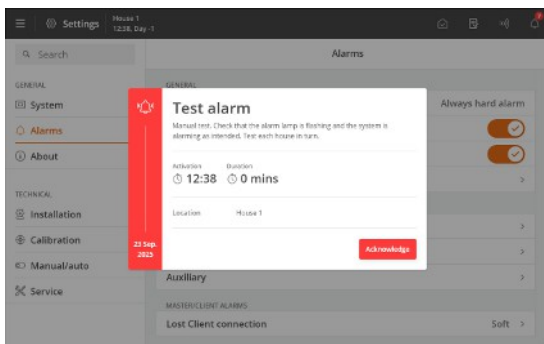

Activate **Alarm test** to start testing.

Check that the alarm lamp is flashing.

Check that the alarm system alarms as intended.

Press **Acknowledge** to finish testing.

## 5 Production

It is of particular importance to know the weight of the animals to monitor and control their productivity.

Being able to control animal behavior means providing the right amount of light in the right places at the right time.

Changes in water consumption can indicate disease outbreaks and water loss, increased temperature in the house, or poor feed quality. In the case of a disease outbreak or increased temperature in the house, the animals' water intake will increase.

The production module is adapted to broiler production and enables systematic monitoring and effective control of the production.

- Continuous monitoring and production control
- Advanced feed program ensuring an optimum FCR/PEF
- Light control for good animal welfare
- Water monitoring and control - quick response in the event of irregularities

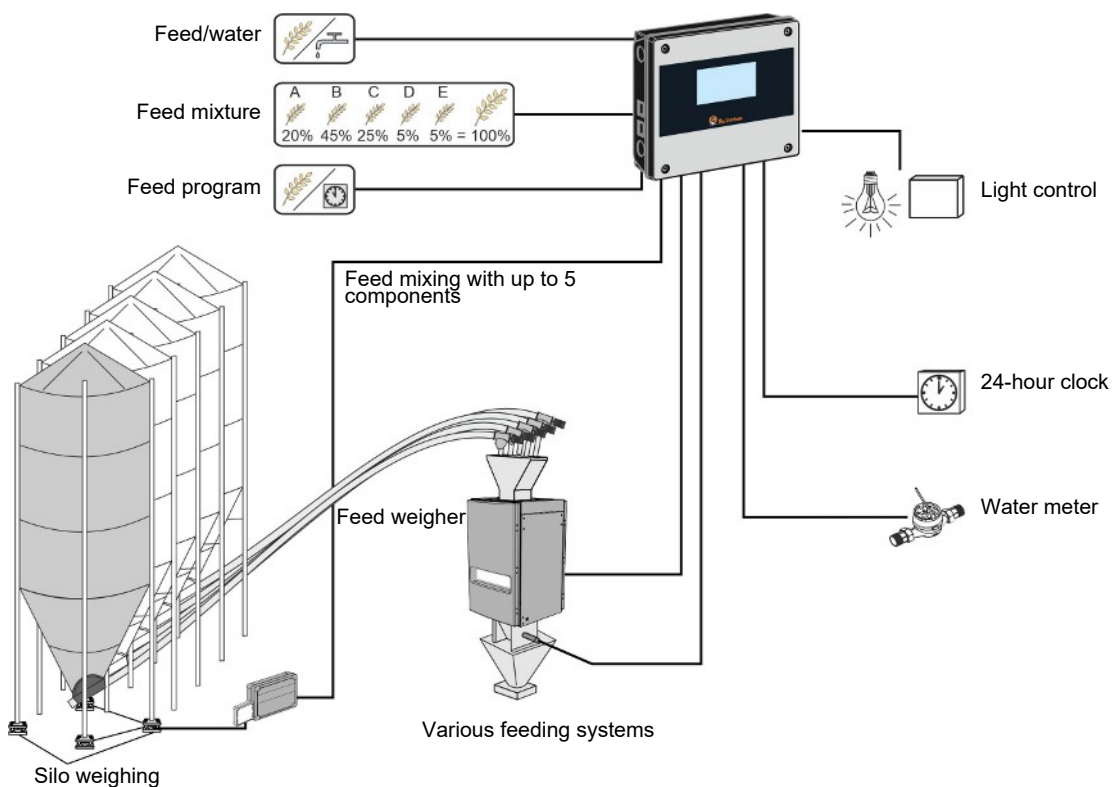

## 5.1 Batch

Information about the number of stocked and moved animals helps to form the basis for the production controller's calculations relating to production control. Key values, such as mortality and feed/animal, are thus dependent on you entering the correct numbers.

The controller continuously calculates the total number of live animals, the number of dead animals yesterday, and the mortality in the livestock house. You can also register the number of stocked animals at the batch start, reasons for culling, etc.

The controller can display whether the registrations were made in the morning or the evening, and a total number of each type of recording for the batch.

Calculations of previous recordings can be viewed in the PC management program BigFarmNet Manager.

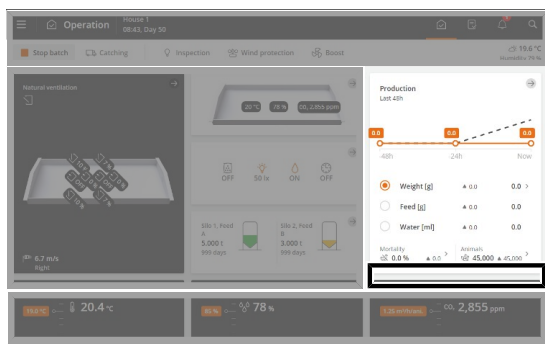

**Operation.** The most important values and recordings for animals in the livestock house can be viewed and entered via the **Production** card.

A graphic on the face of the card illustrates the current weight, feed, and water values during the last 48 hours. In addition, you can see the actual values for mortality and number of animals in the house and have easy access to record the appurtenant numbers during the batch.

**Mortality:** entry of the number of dead animals in different categories.

**Animal:** entry of the number of moved animals.

In the following section, you will see a description of the functions and setting options available for animals.

### Operation | Production card | Animal

<b>Stocked</b>	Entry of the total number of animals at batch start. If animals are stocked or removed from the house during a batch, you can make the entry via the face of the <b>Production results</b> card or the menu <b>Add/remove</b> (moved) or <b>Culled/dead</b> .
<b>Live animals</b>	Displays the number of live animals.
<b>Add/remove</b>	Entry of the number of animals removed or stocked in the livestock house in the different categories.

### Operation | Production card | Mortality

<b>Culled/dead</b>	Entry of the number of animals in categories, including reasons for culling/death. These numbers are used to calculate the mortality rate.
<b>Number of dead animals</b>	Display of the total number of dead animals. Here it is also possible to enter a number instead of in the menu <b>Culled/dead animals</b> . The numbers entered here are included in the recordings under <b>Culled/dead animals</b> in the category <b>Dead</b> .
<b>Number of dead animals today</b>	Display of the total number of dead animals since midnight.
<b>Number of dead animals yesterday</b>	Display of the total number of dead animals.
<b>Mortality</b>	Display of the total calculated mortality in percent.
<b>Livability</b>	Display in percent of the number of live animals compared to the number of stocked animals.

### Operation | Production card | Daily gain

**Daily gain** Display of the animals' gain the last 24 hours.

### Operation | Production card | FCR

**FCR** Display of the calculated feed conversion (**FCR- Feed conversion rate**).  
It reflects how efficiently the animals convert feed into body weight.  
**FCR** is calculated based on: animal weight and feed consumption.  
The lower the **FCR**, the better the feed conversion.

### Operation | Production card | PEF

**PEF** Display of the calculated feed efficiency factor (**PEF- Production Efficiency Factor**).  
It is an overall indication of production efficiency.  
**PEF** is calculated based on:  
Weight (kg) x (100 – mortality (%))  
Age (days) x **FCR**  
The higher the **PEF** value, the better the productivity.

## 5.2 Weight

To achieve optimum production, it is important that the animals' gain follows the recommendations of the breeding company. Gain can be affected by e.g. changing the amount of feed or the light control.

Weighing can be carried out automatically or manually.

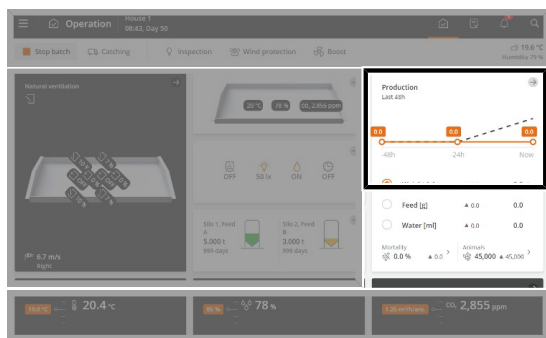

 **Operation. Production.** The card's graphic shows the current average weight for the last 48 hours (14 days for breeder). The card also provides a shortcut for entering the result of manual weighings (inspection weight).

In the following section, you will see a description of the functions and recording options available for weight.

### Automatic weighing

In automatic weighing mode, the controller calculates, among other things, these key values:

- average
- daily gain
- uniformity
- Coefficient of variance
- number of weighings for each bird scale
- distribution of weighings
- number of registrations

These values can also be recorded and calculated based on *animal groups* (for breeders or layers).

### Manual weighing - inspection weighing

Manual weighings should be carried out on the same day and time of the week before feeding to ensure that they are comparable.

- For example, weigh the animals manually on day 7, 14, 21, 28, 35, 42 ... or on the same day numbers as used in the reference curves of the controller.
- Weigh at least 100 birds or 0.5 % of the batch.
- Preferably, you should make at least 4 weighings evenly distributed in the house.
- Enter the average of the manual weighings.

 **Operation | Production.** Press weight data.

---

**Inspection weight**      The inspection weight can be used as a basis for comparison of the automatic weighings.  
 The controller also uses inspection weight to adjust the correction factor. See also below.

---

**Operation | Production |  Weight**

---

**Weight**      Display of key values and a shortcut to historical data and settings.

---

**Correction factor**      Display of correction factor that compensates for the less active and less frequent weighing of heavy animals.  
 The controller calculations take into account the different sizes and behavior of the animals.  
 The value is set as a batch curve under **Strategy**.

---

**Inspection weight**      Entering of manual weighing. See also the section below.

---

**Weight**      Display of a calculated average weight for all animals.

---

 **Operation | Production |  Weight | Weigher | Bird scale**

---

Under the **Summary** heading, selected calculated values are displayed. Additional values can be seen under the individual bird scale.

---

**Average**      Display of the average weight in relation to the weight reference.

---

**Daily gain**      Display of the animals' estimated gain in the last 24 hours.

---

**Coefficient of variance**      Display of the percentage deviation of the animals in relation to the average weight (column) and display of the normal distribution (curve).  
 The higher the standard deviation, the less uniform the animals.

---

**Uniformity**      Display of the percentage of animals that are within a limit of +/- 10% of the average weight.  
 The higher the percentage, the more uniform the animals.

---

**Number of weighings**      Display of the number of weighings in the last 24 hours.  
 There should be at least 100 approved weighings per day (weighings within the search limit).  
 Too few weighings may be due to:  
 - The scale being placed in an area with too few animals and too little activity.  
 - The **Search limit** setting is incorrect.

---

<b>Distribution of weighings</b>	<p>Display of the distribution of approved weighings over a 24-hour period.</p> <p>The views are available for the individual bird scale, per animal group and for females and males.</p> <p>The view is updated by midnight. Press the arrows to access historical data.</p> <p>When comparing views for several days, please note that the x- and y-axis are dynamic and adapt to the number of weighing data.</p>
<b>Number of registrations</b>	Display of the number of stable weighings higher than 25 grams recorded within the last 24 hours.
<b>Average uncorrected</b>	Display of the measured average weight before correction of the correction factor.
<b>Adaptive reference weight</b>	<p>Display of the current weight reference.</p> <p>When using adaptive weighing, the weight reference will adapt if the registered values are above or below the reference.</p>
<b>Animal type</b>	<p>For females and males.</p> <p>Selection of which animal type to be weighed on the scale.</p>
<b>Search limit</b>	<p>Setting limit values for sorting out weighing results.</p> <p>Weighing results above or below this limit in relation to the reference are not used. In this way, the weighing results obtained from weighing more than one animal or other types of incorrect weighings shall be eliminated.</p> <p>See also the section Search limits [ ] 33].</p>
<b>Period for deactivation of bird scale</b>	<p>Setting the period of time in connection with feeding, where the animals are not weighed automatically.</p> <p>See also the section Disconnect period [ ] 32].</p>
<b>Bird scale signal</b>	Display of the current weight recorded by the animal scale (not displayed for manual weighing).

## Strategy | Bird scale curves

<b>Reference</b>	Setting day numbers and reference weight.
<b>Correction factor</b>	<p>Setting day numbers and correction factor.</p> <p>The curve also shows an adjusted factor, which is the controller's correction factor calculation based on the entered inspection weighings. See also the section Correction factor.</p>



We recommend calibrating bird scales at least once per batch.

See also the Technical Manual.

### 5.2.1.1 Correction factor

The natural behavior of the animals results in the heavier animals not stepping onto the bird scale as often as the lighter animals. The recordings from the scale might therefore show a weight lower than the actual weight.

The **Correction factor** function compensates for this weight deviation. This adjusts the recorded weight to reduce the frequency of weighing the heaviest birds.

## Bird scale curves | Correction factor

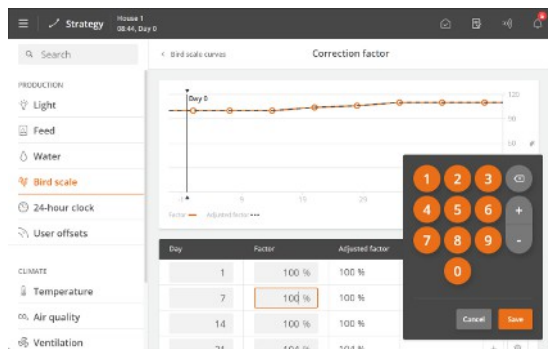

The correction factor is a curve that follows the age of the animals.

We recommend adjusting the curve to the animals in question several times during the batch.

The controller automatically calculates a customized correction factor when an inspection weighing is entered.

The adjusted value is also shown in the curve. The values for the following day numbers are also adjusted.

Refer to section Bird scale [ ] 29] for inspection weighing.

Inspection weight day 21:	330 g
Reference weight day 21:	300 g
Calculation:	$330 / 300 \times 100\% = 110\%$
Adjusted correction factor:	110%

*Example of adjustment of the correction factor based on inspection weight.*

### Batch stop

The adjusted correction factor values must be entered manually if they are to be used for the following batch.

Use the slaughter weight from the slaughterhouse as the last curve point if necessary.

Be aware of the animals' weight loss during catching, transport, and stay at the slaughterhouse. If possible, ask the slaughterhouse for information about weight loss.

From the last feeding to weighing at the slaughterhouse	Weight loss in grams per animal
< 6 hours	0-20
6-8 hours	40-50
8-12 hours	60-70

Table 1: Indicative weight loss figures [g]

### 5.2.1.2 Disconnect period

When feeding, the animals eat and drink a lot in a short time; therefore, their weight also increases greatly. For a period after feeding, the weight of the birds is therefore "false."

It is possible to ignore all the weighings in a given period during and after feeding to get a more accurate average weight. The controller will disconnect weighing for the period of time you set.

If you set **Start** and **Stop** at the same time, the weighing will not be interrupted (The factory setting is 00:00).

With the setting **Start** 23:00 and **Stop** 02:00, the weighing is interrupted for 3 hours from one day to the following day.

### 5.2.1.3 Search limits

The controller only approves weighings within the deviation in percentage from the adjusted reference weight.

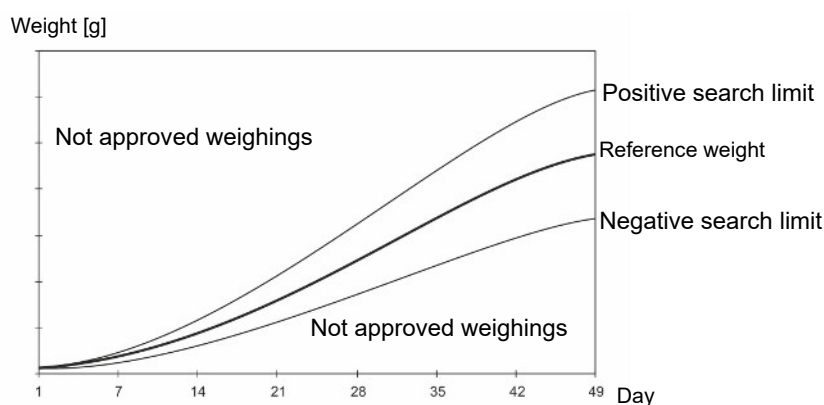

Figure 5: Example of search limit in relation to the reference weight. When the animal type in the controller is set to Males and Females, it is possible to make a positive and a negative adjustment in relation to the search limit.

Day	Reference weight [g]	+/- 15% [g]	Minimum values [g]	Maximum values [g]
1	42	12.6	29.4	54.6
7	162	48.6	113.4	210.6
14	419	125.7	293.3	544.7
21	785	235.5	549.5	1020.5
28	1223	366.9	856.1	1589.9
35	1794	538.2	1255.8	2332.2
42	2143	642.9	1500.1	2785.9
49	2483	744.9	1738.1	3227.9

Example of calculated, accepted minimum and maximum weighings at a search limit of 15%.

## 5.3 Feed

The feed function can be adapted to different types of feeding systems.

Add-on production software can extend functionality to control chain, pan, destination, and layer feeding.

The feed programs and feeding according to reference values enable fully automatic feeding. The feed programs can also be extended with functions such as feed mixture and feed supplements.

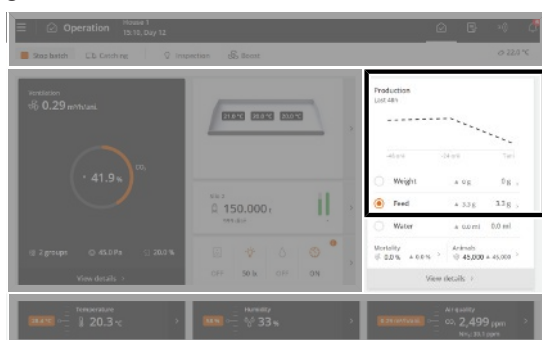

 **Operation. Production** shows a graphic of feed consumption.

### 5.3.1 Handling of feed in the system

At pan feeding, chain feeding, and layer feeding in houses with feed weigher.

To ensure that the final feed consumption is calculated correctly, it is possible to add the feed amount that is already in the system. This can be done by the controller automatically registering and calculating the amount of feed or by manual entry.



It is also possible to enter the weight of feed manually. For example, it may be appropriate to supply feed if there is not enough feed in the silo and feed is provided through other means, or you feed from sacks due to system errors.

### Operation | Program overview card | Manual feed

<b>Add feed</b>	Enter the weight of feed available in the feeding system. Enter (max. 1000 kg at a time).
<b>Remove feed</b>	Enter the weight of feed the animals consume. Enter (max. 1000 kg at a time). The controller uses the data entered to make calculations for feed consumption.

#### 5.3.2.1 Manual distribution of feed before start

In houses with a feed weigher, the controller will fill up the feeding system when you set the house to Active house (see the section House status Active house - Empty house). The amount of feed used for filling is not counted as feed consumption (as the feed has not been consumed but only fills the system).

If you want to manually distribute feed (e.g., on paper) in the house, follow this procedure to ensure that the feed is included in the feed consumption.

1. Wait until the first filling procedure is completed.
2. Take out the feed from the last hopper with the cross auger sensor.

#### 5.3.3 Naming of feed type

It is possible to name the different feed types to suit the individual house, and they can be recognized in menus and alarms.

Naming is done in the menu  Menu button  Strategy |  Feed | Feed type names

#### Please note:

Shared feed weigher and shared silo. Feed type names must be set up for all houses, as the controllers do not share the names.

#### 5.3.4 Feed control

Depending on the type of feed control, the feed can be regulated in terms of time or the amount of feed.

You can change the amount of feed by:

- Increasing/decreasing the amount of feed per day.
- Changing the day number on which the amount of feed is increased in the feed curve.

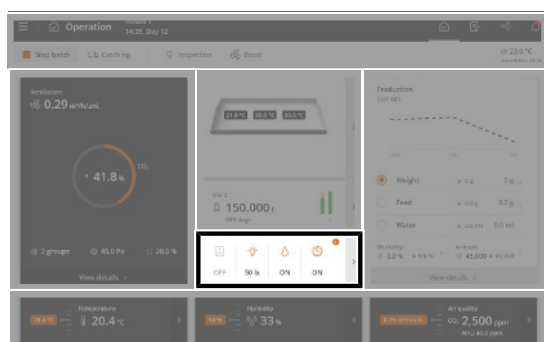

 **Operation**. When the feeding is in progress, it is displayed with a colored icon on the card **Program overview**.

The card provides access to view and change the program, which is active on the day number.

##### 5.3.4.1 Feed programs

The time control of feeding is regulated using the feed programs. The feeding follows a fixed program, which determines at what time of day and the maximum length of time to be fed.

The feed programs can contain up to 16 programs starting on different day numbers. A program is maintained from one day number to the next day number. If no programs have a higher day number, the program applies to the rest of the batch.

Set for each day number (up to 16):

- Number of periods per day
- Start and stop time

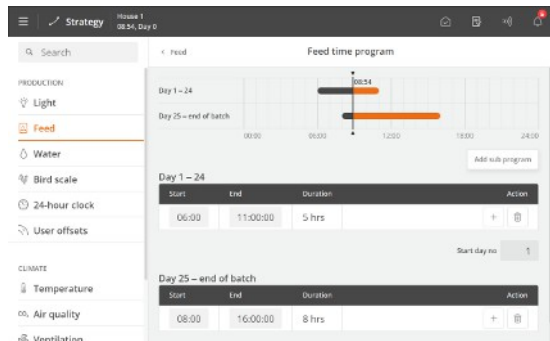

**Strategy | Feed | Feed time program**

Press the field in the column **Start** to set a start time.

Press the field in the column **End** to set an end time.

Press **+** to add a new period.

The blocks on the timeline show when and for how long feeding is taking place.

Press the **Start day no** field to change the day number on which the program begins, if necessary.

Press the **Add sub program** to create a new program starting with another day number.

Press **🗑️** to delete a period.

Please note that:

- On the day before day number 1 (Day 0), the feed relay is always switched on. Feeding has therefore been carried out before stocking a new batch in the house.
- The feeding line is off outside the selected periods. However, the cross auger is still able to fill the cross-auger hopper.
- If a start time is set from 00:00 to 24:00, feeding will be carried out for 24 hours.
- When **Status is Empty house**, feeding is disconnected.
- The feed program must be manually restarted after a feed alarm. See also the section Feed alarms [ ] 58].

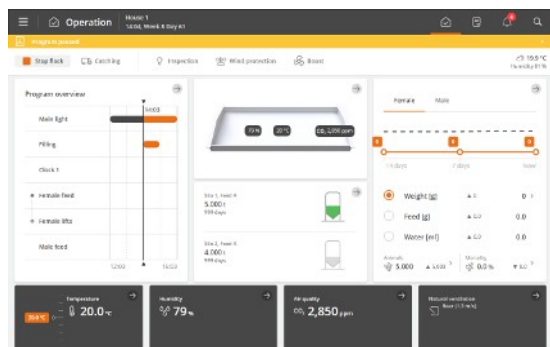

A yellow bar on the display indicates when the feed program is paused. This may be due to a feed alarm or the user paused the feed program.

Press the yellow bar for easy access to restart the feed program.

### Feeding via lighting program

There must be an adequate lighting level in the house during feeding so that the animals are active and seek out the feed. The feeding can also be set up to follow the lighting program. See also the section Light [ ] 46]. The **Feed time program** is not visible if the lighting program regulates the feeding.

### 5.3.4.2 Feed control - pan feeding

In principle, the feeding system is structured as follows:

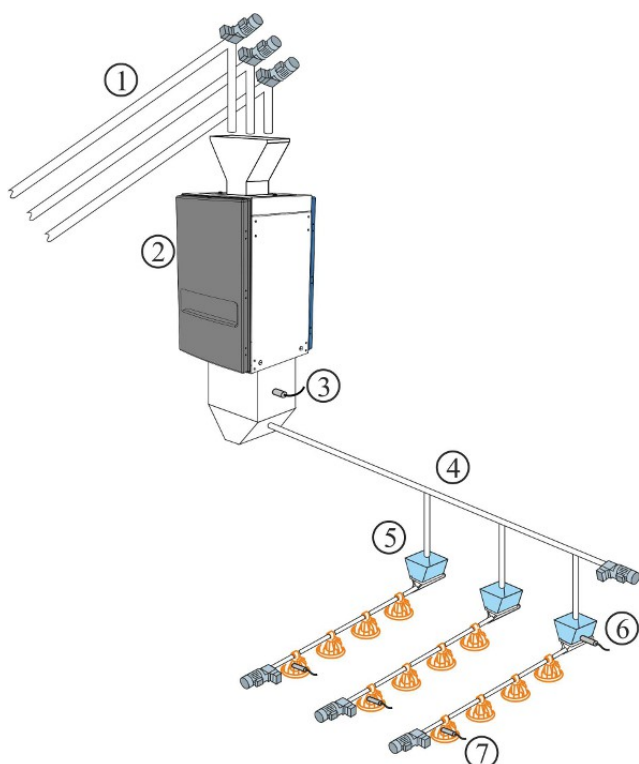

1. Silo auger – up to five types of feed
2. Feed weigher
3. Feed demand sensor
4. Cross auger
5. Cross-auger hopper
6. Cross auger sensor in hopper
7. Level sensor in control pan

When the installation is carried out, set pan feeding according to one of the following control methods: See also the Technical Manual.

- Time-controlled [ ] 37]
- Time- and amount-controlled [ ] 37]
- Time- and amount-controlled with distribution [ ] 38]

#### 5.3.4.2.1 Time-controlled pan feeding

Feed is dispensed in the time intervals set in the feed program.

A sensor in the cross-auger tank of the last feed line registers whether there is a requirement for feed supply. If so, the cross auger fills up all the tanks during the feeding period. The system stops when the sensor is covered by feed.

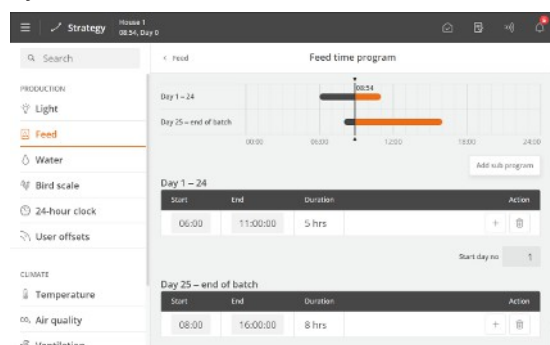

#### Feed program

Setting the feed program. See the section Feed programs [ ] 35].

The quantity of feed the animals are expected to eat is determined in a feed reference curve. If the time it takes the animals to eat changes suddenly, it can indicate problems that should be investigated further.

#### 5.3.4.2.2 Time and amount controlled pan feeding

Feed is dispensed in the amount set in the feed reference curve and in the time intervals set in the feed program or the lighting program under **Strategy**.

If the controller is part of a network with the management program BigFarmNet Manager, the reference curves must be set there. An offset value may, however, be set directly at the controller.

The feed program is set as described in the section Feed programs.

### Period only with time control

Time and amount controlled feeding can be set to be active only for part of the batch. A start day and an end day indicate in which part of the batch the time and amount controlled feeding applies, respectively. Outside this period, only time controlled feeding is applied according to the feed or lighting program. (is set by pressing the **Menu button | Settings | Installation | Manual installation | Production | Feed control settings | Controlled feeding**).

#### 5.3.4.2.2.1 Feed periods distribution

Prog	Day	No. Starts	Period 1	Period 2	Period 3
Prog 1	1	3	33.3 %	33.3 %	33.3 %
Prog 2	25	2	50.0 %	50.0 %	-
Prog 3	45	1	100.0 %	-	-

**Menu button | Strategy | Feed | Distribution of feeding periods**

In the feed programs, several daily starts are set for each program.

The desired amount of feed on the day (as indicated in the reference curve) can be divided between the number of starts (periods).

If a period changes, the controller automatically adjusts the successive values. Therefore, make the changes, so they follow the periods' sequence.

#### 5.3.4.2.3 Time and amount controlled pan feeding with distribution

For time and amount controlled feed, the controller calculates whether the amount consumed corresponds to the consumption required. The controller automatically adapts the amount in successive periods if more or less than the required amount has been consumed. See also the section Feed periods distribution [ 38].

Consumption is checked when the animals have finished eating. That is, when the controller no longer records consumption.

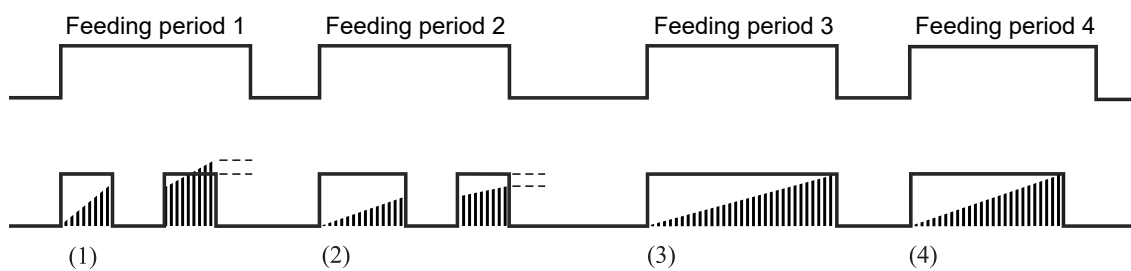

Figure 6: Example of correction of feed consumption over periods.

- (1) Too much feed is deducted from the next feeding period.
- (2) Is stopped by the feed program. Too little feed is transferred to the next feeding period.
- (3) No correction. The feed program stops feeding. The feeding amount is as required.
- (4) Feeding stops before the feeding period ends. The animals have not eaten for a set period (**Check consumption when birds full**) and have received the required amount of feed.

The controller stops the feeding period if more feed has been allocated than required. An amount corresponding to too much feed allocated compared to the required amount will be deducted from the necessary amount of feed for the next feeding period.

If less than required has been allocated, the controller starts refeeding after a pause.

The controller stops the feeding period if the required amount has now been reached.

If the amount has not been reached, feeding will continue until the required amount of feed has been achieved or the feeding period has ended. If the required feeding amount has not been reached before the end of the feeding period, the lacking amount of feed will be transferred to the next feeding period.

To set up **Controlled feeding**, you press the **Menu button | Settings | Technical | Installation | Manual installation | Production | Feed control settings | Controlled feeding**. See also the Technical Manual.

### 5.3.4.3 Feed control – chain feeding

In principle, the feeding system is structured as follows:

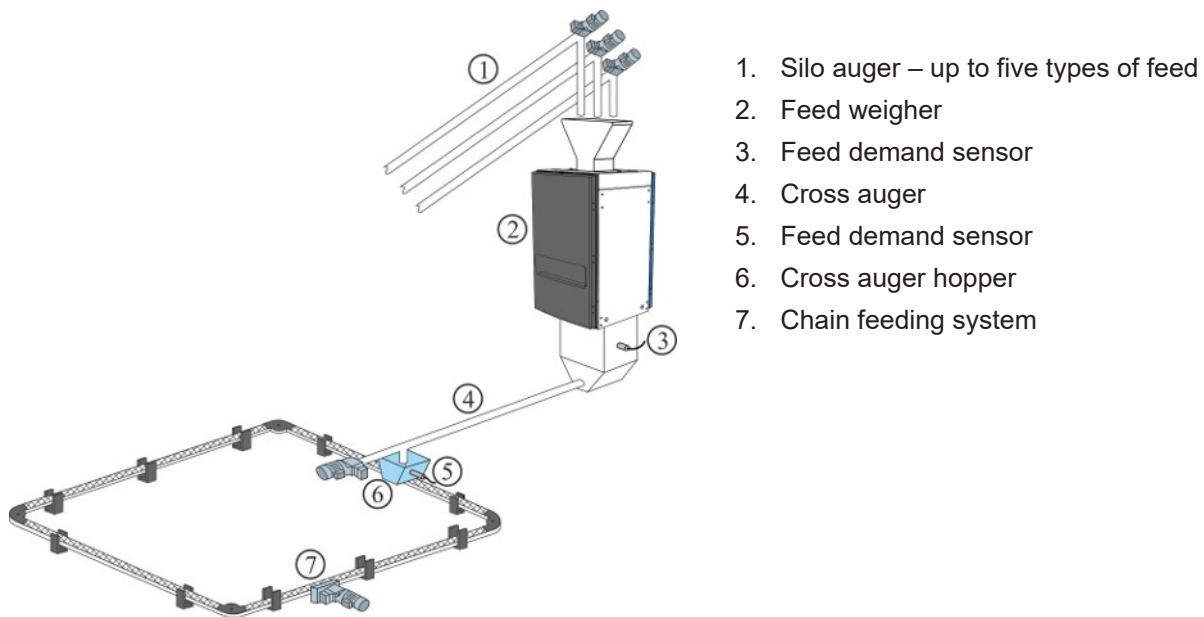

When installation is carried out, chain feeding is set to one of the following control methods: See also the Technical Manual.

- Time-controlled
- Control according to light program

Chain feeding controls feeding by supplying feed daily for a number of times during the set periods of time.

#### 5.3.4.3.1 Time-controlled chain feeding

##### Feed program

Set the feeding periods. Also see Feed programs [ ] 35].

The menu **Feed program** is not visible if chain feeding is controlled according to the lighting program.

##### Chain runs

☰ Strategy | 🏠 Feed | Chain runs

Set for each feed program:

- Day number
- Number of daily chain runs

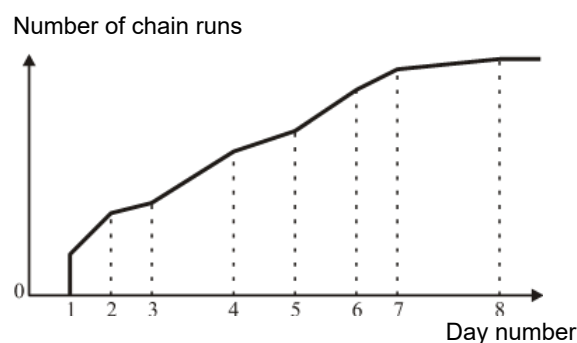

Figure 7: Chain feeding: Number of chain runs per day.

The number of daily chain runs gradually increases between two day numbers.



Figure 8: Chain feeding: Example 1: Distribution of number of chain runs

The number of chain runs is distributed equally between the number of starts. Excess chain runs are distributed from the last start.

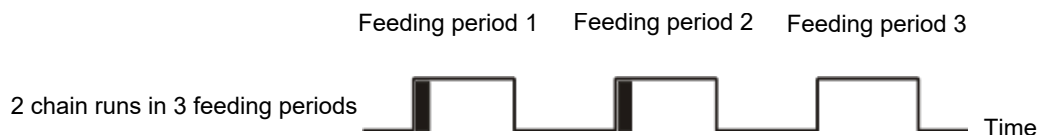

Figure 9: Chain feeding: Example 2: Distribution of number of chain runs

If the number of chain runs is less than the number of starts, feeding is carried out once at each start until the set number of chain runs is reached.

### Program overview | Feeding | Feed settings

<b>Chain last start time</b>	Display of the latest chain start.
<b>Chain next start time</b>	You can set a manual chain start if you want to change the start time with in relation to the feed program.  The controller postpones the chain start if the cross auger hoppers are not full.
<b>Total number of chain starts today</b>	Display of the calculated number of chain starts for the current day. The number gradually increases between two day numbers.
<b>Total number. of chain starts yesterday</b>	Display of the total number of chain starts yesterday compared with the number of the current day.
<b>Number of chain runs to-day</b>	Setting several chain runs for the current day.  The number of chain runs is otherwise set in the feed program. The following days will proceed using the same offset.  If this number is higher than the calculated number of chain runs, there are too many runs compared to the length of the period.
<b>Number of chain runs to-day calculated</b>	Display of the number of chain runs that can be applied within the periods.
<b>Number of chain runs offset</b>	Display of the offset compared to the number of feedings set in the program.
<b>Chain runtime</b>	Setting the runtime for one chain rotation. It is important to set this parameter correctly.
<b>Manual chain start</b>	Activation of manual feeding.  A manual start can be activated before and after the programmed feedings. It will not affect subsequent feedings.

#### 5.3.4.4 Feed mixture

When a drum weigher or FW 9940-2 is used, the controller can handle feed mixtures of up to 5 types of feed.

Feed	Current	Offset
Feed A	60 %	-5 %
Feed B	5 %	0 %
Feed C	10 %	0 %
Feed D	15 %	5 %
Feed E	10 %	0 %

**Operation | Program overview card | Feed settings | Feed mixture**

The feed mixture can be adjusted with an offset without changing the feed mixture curve. The proportion of feed B, C, D, and E is adjusted according to the current curve.

By subtracting the offset value from **Current**, it is possible to re-set the offset and return to the original curve value.

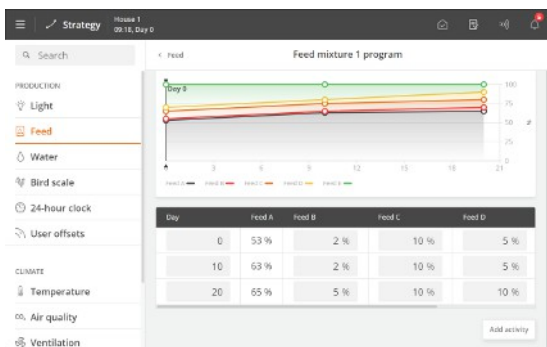

**Menu button | Strategy | Feed | Feed mixture**

A mixing program with 8 programs controls the mixture of different feed types.

Enter the desired quantity in percent of feeds B, C, D, and E. The controller then calculates the amount of feed automatically.

The controller changes the mix proportion continuously, from day to day, to prevent sudden changes in the feed composition.

One offset is added to the feed mixture curve. If very high offset values have been set, **Feed X today** may, in time (when the curve rises and falls) exceed 100% or fall below 0%. In that case, the **Feed X today** value should be corrected. However, the controller will always calculate the correct mix proportion.

**Operation | Catching | Control**

**Type of feed when feed mixing is stopped**      Catching. Displaying the type of feed selected for the transition to Catching. See also the Catching section.

### 5.3.5 Feed weigher

FEED WEAHER	
Feed supply state	No feed demand
Feed weigher state	Idle

**Program overview | Feeding | Feed settings**

The controller provides information about the filling of the weigher and the current status of the weigher.

## 5.4 Water

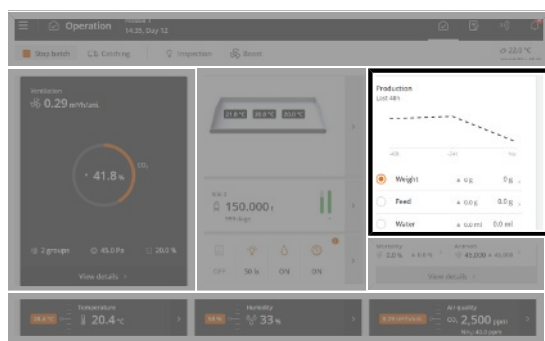

**Operation | Production.** A graphic shows the current average water consumption for the last 48 hours (14 days for breeder).

In the following section, you will see a description of the functions and recording options available for water.

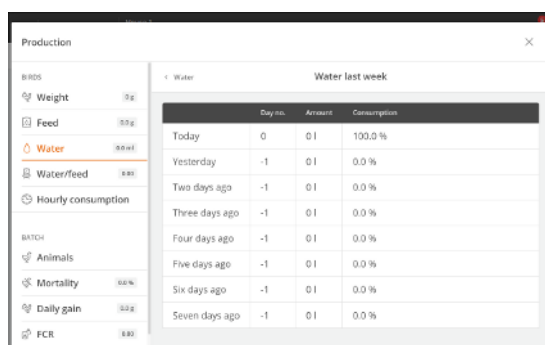

**Operation | Production | Water**

Water data is collected and presented in graphs and outlines, including important key figures.

The controller records the water consumption in liters to provide a complete overview. The water consumption is also recorded in percent to make sudden changes visible.

Under normal conditions, the percentages will increase by a few percent per day as the age of the animals increases.

**Operation | Program overview | Water settings** (only for water control)

<b>Water program state</b>	Displays whether the controller has turned the water on or off. When setting up water alarms, it is possible to choose whether the water should be turned on or off when an alarm is generated.
<b>Water amount this period</b>	Display of water consumption in the current period.
<b>Water target amount</b>	Display of the maximum amount of water the animals are allowed to consume in the current period.
<b>Water reference</b>	Display of the water consumption target per animal in the current period.

### Water level alarms

The water level alarm is used to monitor the water level to ensure that there are no breaks on the drinking lines. It quickly shows water supply errors, such as blockage, broken water pipes, or lack of water supply. The primary purpose is thus to ensure a stable water supply for the animals. See also the section Water alarms [ 61].

Level	No.	Name	Enabled
Low	4	Water level 4	Yes
OK	1	Water level 1	Yes
OK	2	Water level 2	Yes
OK	3	Water level 3	Yes

Input terminals in alarm mode are displayed at the top of the list. Next, the faulty input terminals are displayed, which are monitored before an alarm is released. At the bottom of the list, you find the input terminals where the status is OK.

<b>Water level alarms</b>	Display of the current water level alarms. The list is sorted continuously according to the status of the input terminals ( <b>Critical, High, Low, OK</b> ).
<b>Enable/disable individual water level alarm</b>	Connection and disconnection of the alarm for each water level input.

### 5.4.1 Water control

The controller has 4 types of water control:

- Time controlled according to the program
- Time controlled according to the lighting program
- Time and amount controlled according to the program
- Time and amount controlled according to the lighting program

In the case of time and amount controlled water, the controller turns off the water when the desired amount has been consumed.

It is also relevant to install water control to draw attention to alarms to quickly monitor leakages and blockages in the water system.

In principle, water control works as feed control. The water program can contain up to 16 programs starting on different day numbers. A program is maintained from one day number to the next day number. If no programs have a higher day number, the program applies to the rest of the batch.

Set for each day number (up to 16):

- Number of periods per day
- Start and stop time

**Please note that:**

- During the time up to the first day number, the water supply is open all the time.
- That there is no access to water outside the periods selected.
- If a start time is set from 00:00 to 24:00, water is available around the clock.

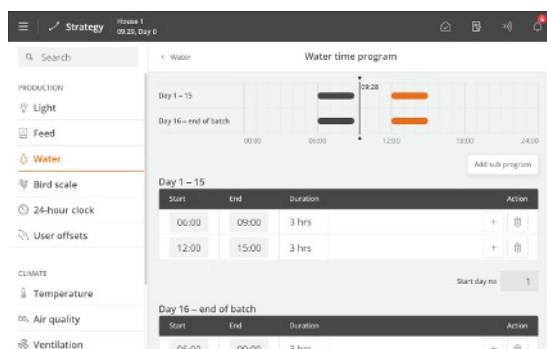

#### Water time program

Menu button | Strategy | Water | **Water time program**

Press the field in the column **Start** to change the start time.

Press the field in the column **End** to change the stop time.

The blocks on the timeline show when and how long the water is available.

Press to add a new period.

Press the **Start day number** field to change the day number on which the program begins, if necessary.

Press the **Add subprogram** to create a new program starting with another day number.

Press to delete a period.

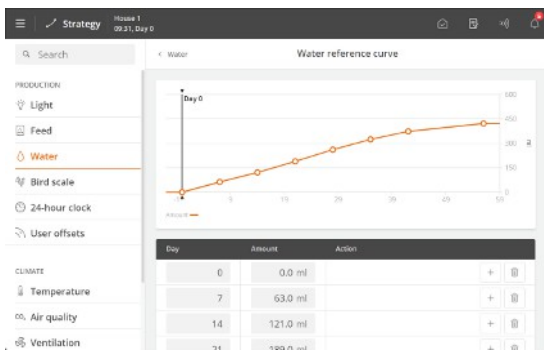

### Water reference curve

☰ Menu button | 📊 Strategy | 💧 Water | **Water reference curve**

The available water quantity is determined in a water reference curve.

Prog	Day	No. starts	Period 1	Period 2
Prog 1	1	2	50.0 %	50.0 %
Prog 2	15	2	40.0 %	60.0 %

### Water distribution by periods

☰ Menu button | 📊 Strategy | 💧 Water | **Water distribution**

Several starts for each program are set in the water programs.

The desired amount of water on the day (as indicated in the reference curve) can be divided between the number of starts (periods).

If a period changes, the controller automatically adjusts the following values. Therefore, make the changes so they follow the periods' sequence.

## 5.5 Light

Among other things, the light can be used to adjust the animals' behavior during the day as increased light intensity increases the activity and decreased light intensity decreases the activity.

The controller has 3 types of program-controlled light:

- Main light
- Slave light
- Extra light

And inspection light which is manually controlled (breeder stand-alone or by add-on software).

Each type of light has various settings options depending on how the light is installed and set up.

	Mode	Program	Light intensity
Main	Standard (dimmer)	Yes	Dawn/dusk
		Reduced main light	Fixed level
	Flexible (dimmer)	Yes	Up to 30 points a day
	Standard (ON/OFF)	Yes	No
Slave	Standard (dimmer)	No. Offset to main	Dawn/dusk
	Standard (ON/OFF)	No. Offset to main	No
Auxiliary	Flexible	Yes	Up to 30 points a day
Inspection	Manual (automatic stop)	No	Fixed level

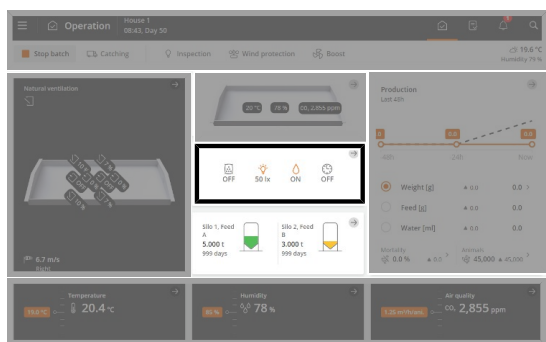

 **Operation.** When the light is on, it is displayed with a colored icon on the card **Program overview**.

The card provides access to view and change the program which is active on the day number.

### 5.5.1 Light program

In principle, the light control works as feed control.

The light program can contain up to 16 programs starting on different days numbers. A program is maintained from one day number to the next day number. If no programs have a higher day number, the program applies to the rest of the batch.

Set for each day number (up to 16):

- Number of periods per day
- Start and stop time

**Please note that:**

- The light up to the first day number is on 24 hours a day with the same light intensity as for Day 1.
- That there is no access to light outside the periods selected.
- Light is available around the clock if a start time is set from 00:00 to 24:00.

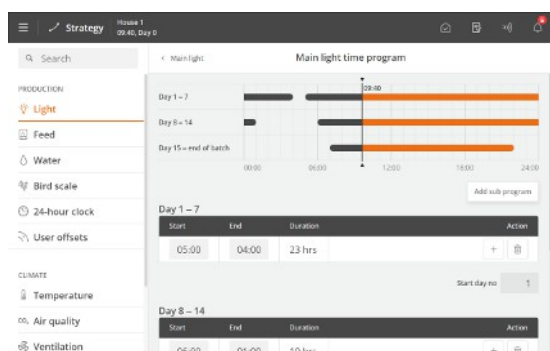

☰ | Menu button Strategy | 💡 Light

Press the field in the column **Start** to change the start time.

Press the field in the column **End** to change the stop time.

Press **+** to add a new period and set the start and stop time.

Press the field **Start day no.** to change the day number of the period, if required.

Press **Add subprogram** to add a new day number.

The blocks on the timeline show when and how long the light is on.

Press **🗑️** to delete a period.

## 5.5.2 Main light

The controller has 2 types of main light:

- Standard – same light intensity all day (but with reduced light, and dawn and dusk options)
- Flexible - different light intensities during periods of the day

### 🏠 Operation | Program overview card | Main light settings

<b>Main light intensity set-point</b>	The setting of light intensity for the main light (with light dimmer).
<b>Main light off intensity setpoint</b>	The setting of minimum light intensity (with light dimmer). The setting of light intensity when the lighting program is OFF.
<b>Main light sensor value</b>	Reading of the current light intensity measured by the light sensor (with light sensor). When there are more sensors, the controller shows an average value.
<b>Light sensor history</b>	Graphic display of the history curve values in different time intervals from 24 hours to 2 months.
<b>Reduce main light</b>	Reading of whether the reduction of the main light is ON or OFF. See section Reducing main light [ 49].

### ☰ | Menu button Strategy | 💡 Light

<b>Main light time program</b>	The controller automatically regulates the light in the house based on the values you indicate in the <b>Light time program</b> menu.  The time program is set as described in the section Light program [ 46].
<b>Light intensity relative to setpoint</b> (Only at flexible light)	The setting of the light intensity in percent relative to 100% light intensity during periods of the day. See section Flexible light settings [ 49].
<b>Main light intensity curve</b>	The setting of the light intensity of each day number.
<b>Dusk and dawn</b> (Only at standard)	Settings of periods with increasing and decreasing light intensity for transition between light and darkness in the house. See also the Dawn and dusk [ 48] section. Only available in houses with light dimmers.
<b>Settings for flexible main light</b> (only at flexible)	Menu for setting light programs.  The controller automatically regulates the light in the livestock house based on the values you indicate in the menu.  The program is set as described in the section Flexible light settings [ 49].



Please note that there may be correlation between feather pecking, injury, mortality and the light intensity in the house.

### 5.5.3 Dawn and dusk

The function is intended for houses with standard lighting control.

When a light dimmer is used, the light level can be controlled so that a light period starts with "Dawn" where the light is changed from "Night" to "Day". Similarly, a light period ends with "Dusk".

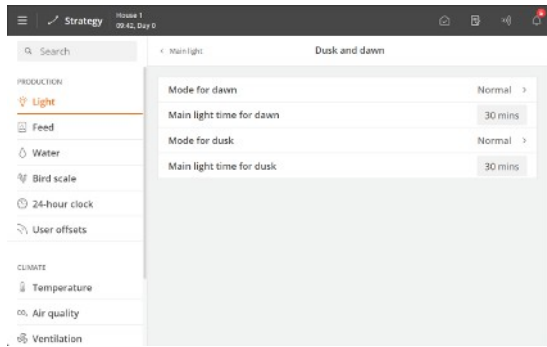

Over a set period, the controller changes the light to the required level.

Periods for dawn and dusk can be set independently.

Set the duration of the individual periods and the value of the light intensity when the period expires.

Start time: 14:00  
Dawn: 00:20

Dusk: 00:30  
Stop time: 16:00

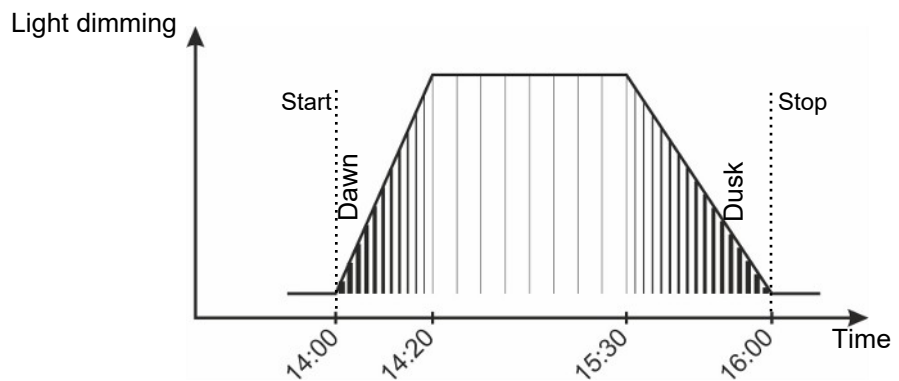
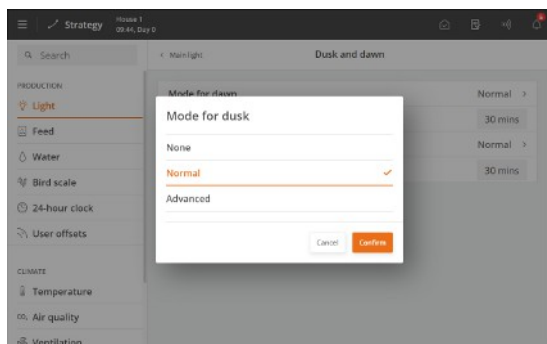

Figure 10: Normal light dimming Dawn and dusk are integrated in the light period.

#### 5.5.3.1 Dawn and dusk - advanced

The dawn and dusk periods can follow a selected sequence of time, independently of each other: **Normal** or **Advanced**.



**Normal:** Over a set period, the controller changes the light to the required level

**Advanced:** Over three periods, the controller changes the light to the required level.

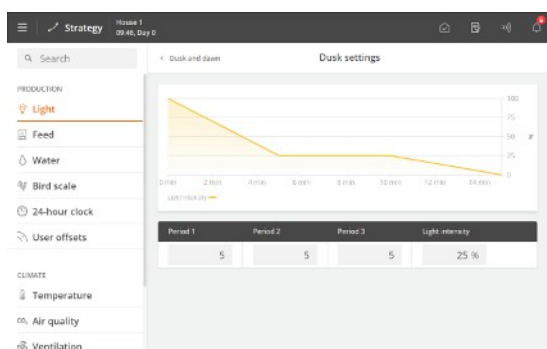

### Advanced

Set the duration of the individual periods as well as the value of the light intensity when the period expires.

## Operation | Catching

### Light control

Catching. See also the section Catching.

Selection of activation/deactivation of the different light types at catching.

Display of the status for catching light.

## 5.5.4 Reducing main light

The function is intended for houses with standard lighting control. Changing the light level for a period every 24 hours can contribute to regulating the behavior of the animals. A lower light level would thus make the animals calmer.

### Operation | Program overview card | Reduce main light

**Reduce main light state** Reading of whether the reduction of the main light is ON or OFF.

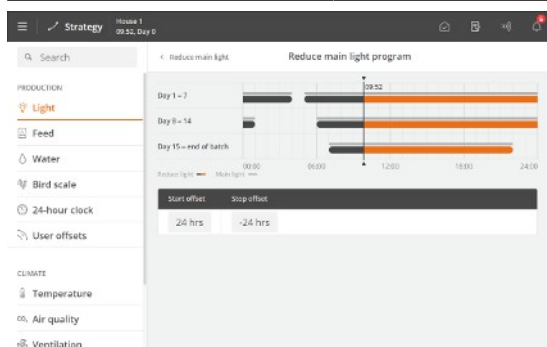

**Start offset** and **Stop offset** must be within the ON time of the light program.

### Menu button | Strategy | Light | Main light | Reduce main light

**Start offset** The light reduction starts after the lighting program has started. Setting how long after.

**Stop offset** The light reduction stops before the lighting program stops. Setting how long before.

**Reduce main light program** Setting the light reduction according to the main light program.

**Reduce main light intensity to** Setting the light intensity level to which the main light should be reduced.

**Time to reduce main light** Setting how much time should pass from the start and stop of the light reduction until the light intensity is back to the normal level.

**Time to return to main light**

## 5.5.5 Flexible light settings

When the light control is set to **Flexible**, the light intensity can be adjusted within the on period(s) with up to 30 points and can be adjusted in percent compared to 100% light intensity for periods during the day.



It may be advantageous to start by setting a start and a stop time where the light intensity is 0% to limit the light on period. Then you can set the individual time periods where the light intensity should deviate from 100%.

Create a light program. See section Light program [ 46].

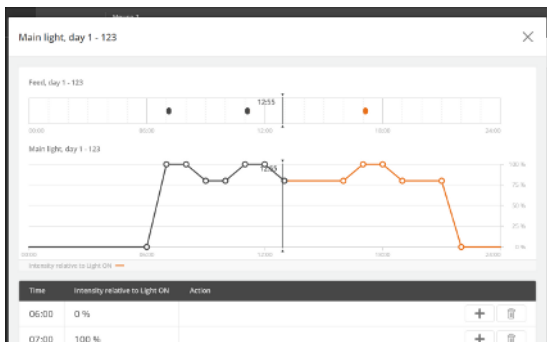

**Operation | Program overview card | Main light**

Press the field **Time** to set the time.

Press the field **Light intensity relative to setpoint** to set the light intensity at this time.

Press **+** to add a point in the program.

Press to delete a time/point.



The feed program is visible on the card at layer feeding with feed program. Thus, you can choose to adjust the light intensity according to the feeding times.

### 5.5.6 Follower light

Follower light is a feature that is activated at a different time than the main light. In addition to an alternative light source, this could include, for example, curtains that block out the light from windows.

The offset can be adjusted using the start and stop offsets for each follower light.

**Operation | Program overview | Follower light 1 settings**

**Follower light 1 intensity setpoint** Adjusting the light intensity of the follower light (using the dimmer) if you want to change the light intensity relative to the program.

**Follower light 1 OFF intensity setpoint** Setting of minimum light intensity (using the dimmer).

Changing the light intensity when the lighting program is OFF if you want to change the light intensity relative to the program.

**Menu button** | **Strategy** | **Light** | **Follower light**

**Follower light 1 program** Setting the **Start offset** and **Stop offset** program to determine when the follower light is turned on relative to the main light.

The offset can be set to a positive or negative value, depending on whether the follower light should turn on before or after the main light.

**Follower light 1 intensity curve** Setting the light intensity curve for the follower light.

**Start offset relates to** Set whether the follower light should turn on before or after **Start time** or **Stop time** set in the light program.

**Start offset to when Main light turns on** Setting of curve point for **Start offset** in the follower light program.

**Stop offset relates to** Set whether the follower light should turn off before or after **Start time** or **Stop time** set in the light program.

**Stop offset to when Main light turns off** Setting the curve point for **Stop offset** in the follower light program.

**Dusk and dawn**

Settings of periods with increasing and decreasing light intensity for transition between light and darkness in the house.

See also the section Dawn and dusk [ ] 48]. Only available in houses with light dimmers.

When using a dimmer for the follower light, the **Light intensity**, **Light OFF intensity** and **Light intensity offset** settings function as described for main light.



The main light program is shown above the follower light program in the menu.

**5.5.7 Extra light**

Among other things, extra light can be used to, for example, control light according to a separate light program in specific parts of the livestock house. Extra light has the same settings options as the flexible main light, see Flexible light settings [ ] 49].

**Operation | Program overview card | Extra light**

<b>Program</b>	Setting of <b>Light intensity relative to setpoint</b> in the lighting program. The program is set as described in the section Flexible light settings [ ] 49].
----------------	--

**Operation | Program overview card | Extra light 1 setpoint**

<b>Extra light 1 intensity setpoint</b>	Setting the light intensity for the extra light.
<b>Extra light 1 OFF intensity setpoint</b>	Setting of minimum light level. Setting of light intensity when the light program is OFF.

**Menu button | Strategy | Light | Extra light**

<b>Extra light 1 time program</b>	The time program is set as described in the section Light program [ ] 46].
<b>Extra light 1 intensity curve</b>	Setting the light intensity for the extra light.

**Menu button | Strategy | Light**

<b>Light color</b>	Menu for setting the time and light color (in Kelvin). The controller automatically adjusts the light color in the livestock house based on the values you set in the menu <b>Light color program</b> .
--------------------	--

**5.5.8 Inspection light**

The inspection light is used to control the light when entering the house.

All types of light can be used as an inspection light (main light, follower light, and extra light). The light is switched on in the controller menu.

**Operation | Inspection**

<b>Duration</b>	Setting for how long the inspection light should be on. The light automatically returns to normal light after the set period (maximum 3 hours).
<b>Active</b>	Activation of the inspection light. When the inspection light is on, it is displayed with a colored icon.
<b>Light intensity</b>	Only for lights with dimmer. Setting the light intensity of the inspection light.
<b>Light during inspection</b>	Only for relay-controlled lights. Option to turn off the lights when inspection lights are on.

### 5.6 Silo

To monitor the feed consumption, it is important to know how much feed is filled into the silos. The quantity of feed delivered can be recorded manually or automatically in the controller. In the case of electronic silo weighing, the recording of the delivered feed quantity is automatic.

The controller receives data from the feed weigher to determine the amount of feed consumed from each silo and calculates the feed consumption accordingly.

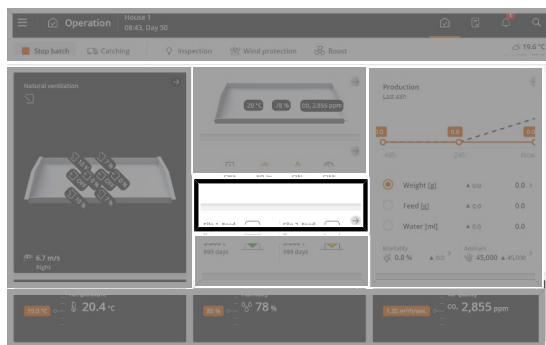

**Operation**

The silo card on the operation page shows the current silo content, feed type, and number of days until the silo is calculated to be empty.

The graphic shows in a green color from which silo feed is being taken (is active) and in colors how much food is left. The color changes and reflects the alarm levels according to when the silo is empty. A gray color shows an inactive silo.

The silo card provides access to the silo settings.

Displays whether a silo is selected or in the process of being changed or replaced

Indicates that the card provides access to submenus

Displays shared silo

Displays feed delivery in progress

Feed delivery button

Silo name

Feed type

Silo content

Number of days until the silo is empty

The silo card shows the status of each silo and collects relevant information and settings.

---

 **Operation | Silo card |  Feed delivery**

---

**Feed delivery** Enter the delivered quantity of feed.

**Feed type** Selection of the delivered feed type.

---

 **Operation | Silo card |  Silo card**

---

**Feed type** Selection of the feed type contained in the silo.

Each type of feed can be named to match the content of the silo - e.g. growing feed (under **Strategy | Feed | Feed type names**).

---

**Current content** Manual entry feed amount in silo.

The user can change the current silo content. The function is most often used to ensure that the controller records an empty silo to have a silo content of 0.

If there is a difference in the silo content displayed, it can also be corrected here.

---

**Feed delivery log** Delivery log with the amount and date for each delivery of feed.

Up to twenty deliveries can be stored for each silo.

---

**Other information** At more than 1 silo with the same feed type

Display whether the silo is selected or not.

Access to manual selection of a different silo.

---

**Silo** Manual mode.

Normally the controller must be set to automatic control. During start up, or in a service situation, it may however be convenient to control the individual functions manually.

After the manual operation, you must set the function back to automatic control, so that the controller continues to operate as before.

---

**Silo empty sensor state** Indication of whether the sensor detects feed.

---

In houses with chain and pan feeding, where feed also is fed manually from the silos, the manual feed can be included in the feed consumption calculations by activating Adjust feed consumption deviation. See the Technical Manual.

 **In connection with electronic silo weighing:**

- It may lead to inaccuracies when the feeding system is running and at the same time feed is being delivered to a silo that supplies feed to the feeding system. It should therefore be avoided.

If feed is still supplied to the silo while the feeding system is running, the controller will stop the feeding during delivery when using pan and destination feeding.

When using layer and chain feeding, the controller uses the experience from normal feedings to calculate the correct delivery amount and the feed consumption.

### 5.6.1 Change to different silo

When a silo runs out of feed, the system can automatically change to another silo that has either the same or different feed type (not for destination feeding).

When setting up the silos, select how the change is to be made. The feed type contained in the silos can be changed directly via the silo card.

When automatic change is used, it may be advantageous to name the feed types in the silos. See section Naming of feed type [ ] 35].

#### Change to a silo with different or the same feed type

This silo setup is used when you have several feed types and want to know the consumption of each feed type.

---

 **Operation | Silo card | Feed replacement | Feed replacement status**

---

<b>Changeover</b>	Displays whether one feed type is currently replaced by another feed type when changing to another silo.  The controller gives a soft alarm when it changes to a different silo.
<b>Reset</b>	Resetting the change to another silo.  If the silo has gone empty by mistake and changed to another silo, it is possible to manually change back when feed has been delivered again.

### Operation | Silo card | Changeover

<b>Gradual changeover</b>	The controller can gradually change to a different silo.  Setting the quantity of residual feed at which the gradual transition is to start. See section Change to different silo [ 53].
<b>Time before changeover</b>	Setting the time before the automatic change of silos occurs.
<b>Minimum silo content before change</b>	The controller considers a silo empty when the quantity of feed is lower than the setting, and the silo auger does not deliver feed to the weigher. It compensates for inaccuracies in the delivery data entered and at the feed weigher.  If a silo is emptied and the quantity of feed in the silo overview is higher than the <b>Minimum silo content</b> , the production controller cannot automatically change. The quantity must therefore be changed to 0,000 tons for it to be able to make an automatic change.

### Menu button | Strategy | Feed | Feed replacement setup

<b>Changeover</b>	Setting up which feed to be changed to when a feed type is about to be used.
-------------------	--

## Change to silo with the same feed type

### Operation | Silo card | Changeover

<b>Automatic change</b>	Setting whether the controller is to change automatically to a different silo with the same type of feed when the active silo is empty.
<b>Gradual changeover</b>	The controller can gradually change to a different silo.  Setting the quantity of residual feed at which the gradual transition is to start. See section Change to different silo [ 53].
<b>Time before changeover</b>	Setting the time before the automatic change of silos occurs.
<b>Minimum silo content before change</b>	The controller considers a silo empty when the quantity of feed is lower than the setting, and the silo auger does not deliver feed to the weigher. It compensates for inaccuracies in the delivery data entered and at the feed weigher.  If a silo is emptied and the quantity of feed in the silo overview is higher than the <b>Minimum silo content</b> , the production controller cannot automatically change. The quantity must therefore be changed to 0,000 tons for it to be able to make an automatic change.

The controller makes the change between the 2 silos gradually (applies only to drum weigher and FW 9940-2).

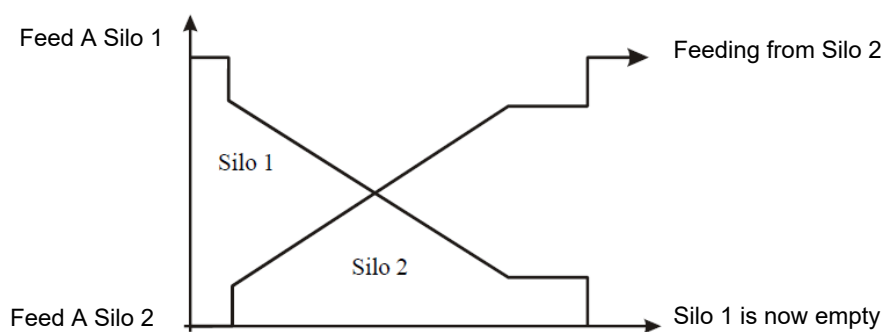
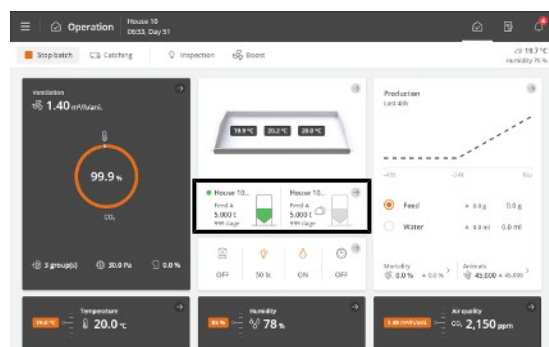

Figure 11: When the content of the silo reaches a set amount, the gradual transition to another silo starts.

If another silo with the sufficient quantity of feed is not available, the production controller will display an alarm: No feed for feed weigher. See also section Feed alarms [ ] 58].

### 5.6.2 Shared silo

A Shared silo is used, for example, where several houses with separate feed weighers are supplied with feed from one silo.



When a silo is shared between several houses, it is regulated by a master controller. Select the master controller and the client controllers during installation.



On the silo card, a shared silo is shown with the icon

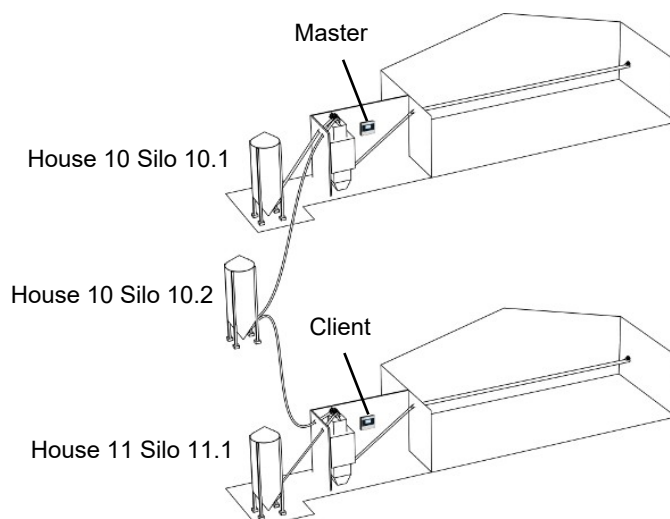

Figure 12: Example of silo shared between two houses with controllers on LAN.

A shared silo has the following values in common with the master controller:

**Operation | Silo card**

**Feed type** Display of the selected feed type.

Please note that feed type names are not shared. If the name of a feed type is changed, it must be corrected in both the master and client controller (**Strategy** menu).

<b>Current content</b>	<p>Display of the current silo content.</p> <p>The controller automatically reduces the silo content with an amount corresponding to the animals' feed consumption.</p> <p>On the master controller, the value can be changed.</p>
<b>Feed delivery log</b>	<p>The feed delivery log is only available on the master controller.</p> <p>Display the amount and date of each feed delivery.</p> <p>The delivered feed amount is entered in the master controller.</p>

See also the section Silo [ ] 52].

### 5.6.3 Day silo – feed weighing

A day silo can be used in large feeding systems to ensure that there is enough feed and prevent the system running out of feed during feeding.

Filling can be performed automatically according to a filling program or manually once.

The day silo will not be filled during feeding or when feeding is paused.



**Operation | Program overview card | Feeding | Day silo**

<b>Day silo content</b>	Reading the current feed amount in the day silo.
<p> Menu button    <b>Strategy</b>    <b>Day silo</b></p>	
<b>Max. capacity</b>	<p>Setting the maximum kilos of feed needed to fill the day silo.</p> <p>The value is the basis for the displayed percentages, e.g., <b>Filling amount</b>.</p> <p>The amount of feed to be filled into the day silo is set for each feeding in the feed program. If possible, it is filled immediately after feeding, so it is ready for the next feeding.</p> <p>Please note that it may be necessary to adjust the filling amount if changes are made to the feed program. See the section Feed programs [ ] 35].</p>

#### 5.6.3.1 Filling of day silo



**Menu button | Strategy | Day silo | Filling**

<b>Filling amount</b>	Setting in percent of the maximum amount to be filled into the day silo.
<b>Filling amount</b>	Reading of the filling amount in kilos.





**Menu button | Strategy | Day silo | Feed mixture**

<b>Feed type</b>	Setting the feed type to use for the filling.
<b>Mixer time</b>	<p>Setting the time the feed mixer is to run after filling.</p> <p>For automatic refilling, a mixing time can be set for each filling in the program.</p>
<b>Start filling of day silo</b>	Manual start and stop of filling. Filling runs until the set filling amount is reached.

## 5.7 24-hour clock

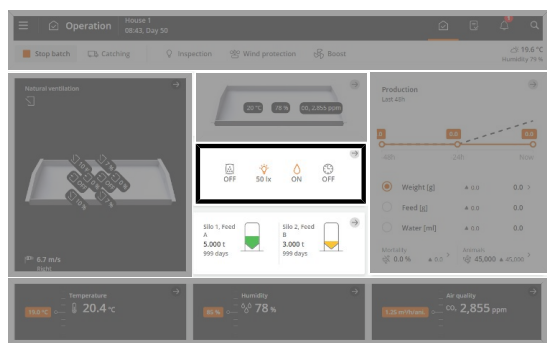
The 24-hour clock function allows you to automatically turn on and off equipment at specific times or time intervals. In addition, the 24-hour clock allows you to choose how often equipment will run in a week. It is done by applying a week program.



 **Operation.** When 24-hour clock is on, it is displayed with a colored icon on the card **Program overview**.

The card provides access to view and change the programs of all the 24-hour clocks.

In each program you must set the following:

- Start time
- Duration

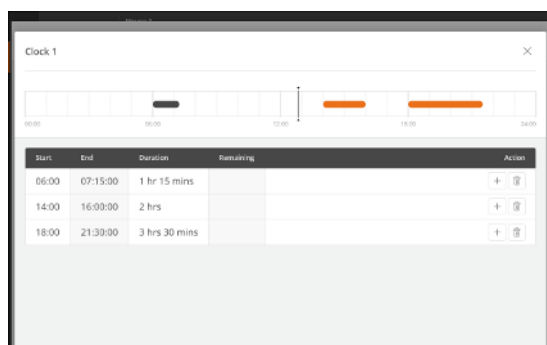

 **Operation | Program overview-card | Clock**

Press the field in the column **Start** to set a start time.

Press the field in the column **Duration** to set the duration of the period.

Press **+** to add a new period, then set the start time and duration of the period.

The blocks on the timeline show when and how long the 24-hour clock is on.

Outside the selected periods, the 24-hour clock is off.

Press  to delete a period.

### 24-hour clock with week program

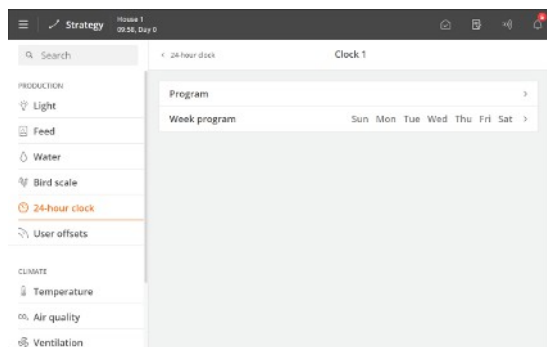

 Menu button |  **Strategy | Production |**  **24-hour clock**

Select which days the 24-hour clock is on.

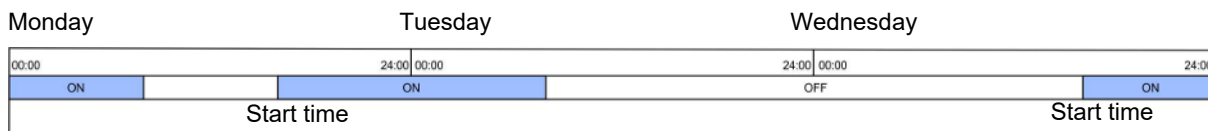

Figure 13: If an ON-time runs past midnight on a day when the 24-hour clock is not active, the function will remain ON until the time has elapsed.

## 6 Alarm settings

The controller has several alarms that will be triggered in case of a technical error or if alarm limits are exceeded. A few of the alarms are always connected, e.g., power failure. The others can be connected and disconnected and alarm limits can be set.



**It is always the user's responsibility to ensure that all alarm settings are correct.**

See also the section Alarms [ ] 25].

### 6.1 Production

#### 6.1.1 Light alarms

The controller has light alarms for the light sensor, main light, slave light, and extra light.

When the light alarm is active, light is not regulated according to light sensors, if any.

☰ Menu button | ⚙ Settings | 🔔 Alarms | Production | Light

<b>Light sensors deviation limit ±</b>	If more light sensors are connected to the same light source (main/slave/extra light), the controller will generate an alarm if the difference in light intensity is too big at the sensors (+/-20 lux).
<b>Alarm delay</b>	Setting a delay for all light alarms to prevent unintended alarms in connection with brief light changes.
<b>Alarm limit</b>	Setting of alarm limit. The controller generates the light alarm if the light intensity deviates (+/-20 lux) from the required level.

#### 6.1.2 Feed alarms

For alarms that pause the feeding program, please note that the feeding program must be restarted manually.

A yellow bar on the display indicates when the feed program is paused. Press the bar to get a shortcut to restart the feed program.

☰ ⚙ Settings | 🔔 Alarms | Production | Feed | Feed weigher

<b>No feed to feed weigher</b>	<p>The alarm is triggered when the feed weigher determines that no feed is coming from the silos. The function can be connected and disconnected.</p> <p>In the event of an alarm, the controller deactivates the silo auger.</p> <p>Set how much time shall pass before the controller triggers an alarm in <b>Time before alarm</b>.</p> <p>The alarm remains active until the feed weigher can register feed again.</p> <p>When the alarm is acknowledged, the silo auger starts again.</p> <p>It is possible to set the silo auger to run and stop alternately for shorter periods after the alarm has been acknowledged. When the silo auger is pumping, feeding may start again if the stop was due to a bridge formation in the silo.</p> <p>The pump function can be overridden by setting the <b>Stop time silo auger</b> to 0 minutes. This way, the controller will ensure that the silo auger stays turned off until the feed demand sensor is manually removed and reconnected. The controllers will then activate the silo auger once in the set runtime (<b>Runtime silo auger</b>).</p>
<b>Missing feed type</b>	<p>One of the feed components included in the mixing program is not available in any of the silos.</p> <p>Check the status of silos and change type of feed in the controller, as required.</p>

<b>Feed weigher can not empty</b>	Feed cannot be discharged from the weigher. As for the drum weigher, the drum cannot turn nor can the stop position be found.
<b>Feed weigher calibration</b>	The calibration of the feed weigher was not finished within the set period of time.
<b>Feed weigher not stable</b>	The feed weigher cannot carry out a stable weighing process. Vibrations may cause this.
<b>Feed weigher reference voltage</b>	The controller recorded that the reference signal from the weigher is less than 9.0V in a given period of time.
<b>Feed weigher hopper not empty</b>	At feed weigher shared between several houses via network. The feed weigher could not empty feed below the feed weigher. Check the empty sensor of the feed weigher and the stop sensor of the cross auger.
<b>Feed shutter incorrect position</b>	At feed weigher shared between several houses via mechanical distribution shutter. The weigher wants to change to the other house, but the distribution shutter does not react.
<b>Cross auger alarm</b>	The controller triggers an alarm if it cannot fill the cross auger hopper back up before the stated alarm time ( <b>Time before alarm</b> ). The controller stops the feeding system to avoid overfilling of feed.  In the case of pan feeding, <b>Stop feed system if cross auger empty</b> in the menu <b>Adjustment</b> must be set to a time shorter than the alarm time for the cross auger.
<b>Not enough feed</b> (not in the case of chain feeding)	The alarm is generated if the consumption of feed is lower than indicated in the period of time selected ( <b>Check interval</b> )  It can be disconnected automatically during the first days of a batch. The alarm is active only during a feeding period.
<b>Too much feed</b>	The alarm continuously monitors whether too much feed is supplied to the house within a time interval.  A system can supply a certain quantity of feed within a period, depending on the size of supply augers and cross augers.  <b>Instructions for setting the alarm limits:</b>  Find the maximum quantity of supplied feed in the feed reference (Day 42, broilers). <ul style="list-style-type: none"> <li>• Maximum feed quantity = 207 g.</li> </ul> Multiply the maximum amount of feed by the number of animals in the house. <ul style="list-style-type: none"> <li>• 207 g x 45,000 animals</li> </ul> Divide by 1,000 to get the consumption in kg (consumption per 24 hours). <ul style="list-style-type: none"> <li>• 207 x 45,000 x / 1,000 = 9,315 kg</li> </ul> The recommended alarm limit is set based on consumption per 24 hours x 2.5. <ul style="list-style-type: none"> <li>• 9,315 kg x 2.5 = 23,288</li> </ul> Calculate consumption per minute. Alarm limit = Consumption per 24 hours x 2.5 / (minutes per day) = consumption in kg/min. <ul style="list-style-type: none"> <li>• 9,315 x 2.5 / (24 hours x 60 minutes) = 16.2 kg/min.</li> </ul> <b>Check interval</b> is set to 45 minutes.  The alarm is triggered if feed consumption during the 45 minutes exceeds <b>Feed consumption within the control interval</b> . <ul style="list-style-type: none"> <li>• 16.2 kg x 45 minutes = <b>727 kg</b></li> </ul>

**Remember** if the check interval is changed, the alarm limit must be recalculated with the new check interval.

If the alarm is generated and no error has occurred, monitoring time should be increased to, e.g., 1 hour.

The alarm can be disconnected automatically at the start of a batch by setting a start day.

---

**Feed consumption decreased**

These alarms can be disconnected automatically at batch/flock start by setting a **Start alarm day**.

The alarm continuously compares the previous 24 hours with the current 24 hours and generates an alarm if consumption deviates by more than the set percentage.

---

**Not enough feed at start**  
(pan and chain feeding)

The alarm must ensure that the feeding system is in order when feeding restarts after a stop.

As a main rule, the alarm limit should be set to 10 kg (**Feed consumption in given check time**).

For chain feeding, monitoring time may not exceed the time for a chain rotation.

An alarm is generated if consumption at the start of a feeding period (or at the start of chain feeding) is lower than indicated in the period of time selected (**Time for alarm check**).

Can be automatically disconnected for the first days of a batch (**Begin to check at day number**).

---

**Too much feed after stop**  
(pan and chain feeding)

The controller monitors whether too much feed has been put through the feed weigher after a feeding period has ended (pan feeding) or the chain has been run through once. Too high a water consumption can indicate that something is wrong.

The cross auger hoppers will be filled up at the end of a feed. The type of hoppers, and how much they are filled up before feeding stops, determines how much feed is used in refilling.

An alarm is triggered if consumption after a feed period (or when chain feeding stops) is higher than the set value (**Max. feed consumption after stop**).

---

**Water/feed ratio**  
(pan and chain feeding with water meter)

The alarm indicates that the water/ feed ratio does not follow the reference curve. Possible reasons:

- 1) Defective water system
- 2) Sick animals
- 3) Feed inaccuracies

However, note that the water/ feed ratio may be increased in houses without cooling systems when the outside temperature is high.

The alarm is generated if the water and feed consumption ratio within a given period of time (**Time for alarm control**) deviates from the value set (**Water/feed ratio alarm limit**).

Can be disconnected automatically during the first days of a batch (Begin to check at day number).

Choose whether the water is to turn off when an alarm is generated. When all water alarms have been acknowledged, the controller turns on the water again.

---

**Feed level too low**

Based on the feed consumption of the previous day, the controller calculates how long it will be until the feed is consumed and will trigger an alarm once this time is exceeded (**Feed level too low**).

A total overall level will be calculated if the same type of feed is in multiple silos.

---

**Silo content | Feed level too low**

---

**Feed A level too low limit**

---

<b>Silo 1 content low</b>	The displayed silo content is a calculated value. The alarm is generated when the feed amount in a silo is below a set limit.
<b>Silo is empty alarm</b>	The empty silo sensor records that there is no more feed in the silo, and it is impossible to switch to another silo, possibly due to too low silo content.
<b>Calibration of silo</b>	
<b>Calibration of silo</b>	The controller will give an alarm if the calibration is not completed within the set time (1 hour). As long as the silo weigher is set for calibration, it cannot be used by the feeding system.
<b>Silo is not calibrated</b>	The controller will give a soft alarm if the electronic silo/day silo is not calibrated after installation. The silo must be calibrated to show the correct data.

### Feed type replacement alarm

<b>Feed X replacement</b>	The alarm indicates that one silo has gone empty, and therefore, feed is automatically taken from another silo. See also the section Change to different silo [ 53].
<b>Day silo content</b> (layer feeding)	The alarm indicates that the content of the day silo is too low (below a set limit) during feeding. The feeding is paused. Check that the filling amount for the day silo is sufficient in relation to the current feed consumption. Start filling the day silo in the menu <b>Production   Day silo   Manual filling of day silo</b> or stop the feeding allowing the feeding system to refill automatically at the next feeding.

## 6.1.3 Water alarms

These alarms can be disconnected automatically at batch/flock start by setting a **Start alarm day**.



**Alarms | Production | Water**

<b>Min. and max. water alarm</b>	The alarms are used for monitoring the animals' drinking patterns. The alarm limits for maximum and minimum water consumption is a set percentage of the normal consumption. The controller calculates the normal consumption by comparing the current 24-hour period with the 24-hour period that is two hours older. At 1 P.M., for example, you look at the period from 11 A.M. on the previous day to 11 A.M. on the current day. Choose whether the water is to turn off when an alarm is generated. When all water alarms have been acknowledged, the controller turns on the water again.
<b>With water control</b>	
	These alarms are used for monitoring leakages and stoppages in the water system.
<b>Not enough water</b>	The alarm is triggered if the water consumption measured by a water meter is too low during a given period of time. It is recommended to set this alarm to 1 l/min. and a monitoring time to 30 minutes. An alarm will be generated if consumption is lower than 30 liters each half hour.

<b>Too much water alarm when open</b>	<p>The alarm is triggered if the water consumption measured by a water meter is too high in a given period.</p> <p>Depending on the capacity of the water supply, the system can supply a certain quantity of water per unit of time.</p> <p>The alarm is triggered when the system has operated at maximum output for too long.</p> <p>If a water relay is installed, the water will be turned off at excessive water consumption.</p> <p><i>Guidelines for alarm limit settings:</i></p> <p>Measure the amount of water flowing per minute to the current water meter. Set the alarm limit for 1 liter less than the measured. Set the monitoring time to 30 minutes.</p>
<b>Too much water alarm when closed</b>	<p>The alarm monitors whether the water system is turned off when it should be.</p> <p>The recommended setpoint for this alarm is 1 l/min. and a monitoring period of 30 minutes.</p>
<b>Water level alarm</b>	<p>Setting the time before alarm.</p> <p>The controller does not trigger an alarm until the water level has been recorded as OFF during this time (15 min). It ensures that brief changes in the water level of the livestock house do not trigger the alarm.</p> <p>The controller does not change the regulation at the water level alarm.</p>
<b>Start alarm on day</b>	<p>Automatic disconnection at the beginning of a batch/flock. To avoid triggering false alarms, you can indicate how many days should pass before the controller triggers a water alarm.</p>
<b>Water level alarm</b> (only destination and layer feeding with DOL 100 water)	<p>The alarm monitors if the water level is sufficient. If the water level is not sufficient in more than 15 minutes (factory setting), it generates an alarm.</p> <p>See the menu <b>Production   Water   Water level alarms</b> to see on which input terminals there is an alarm.</p>

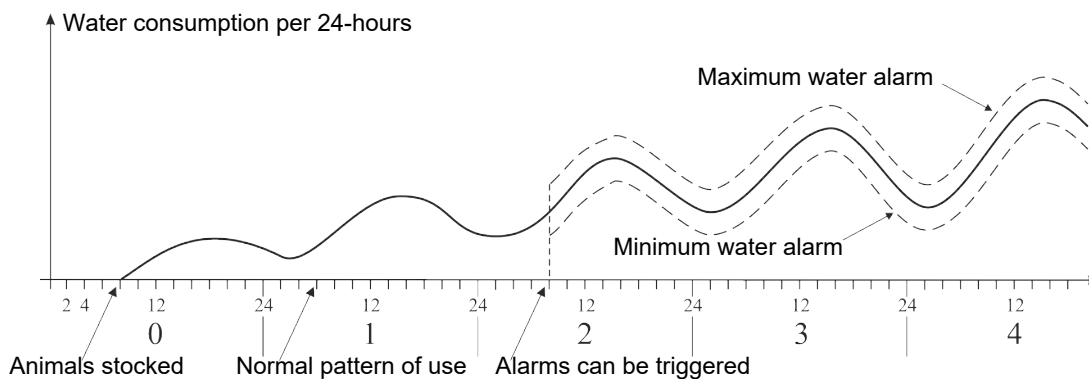
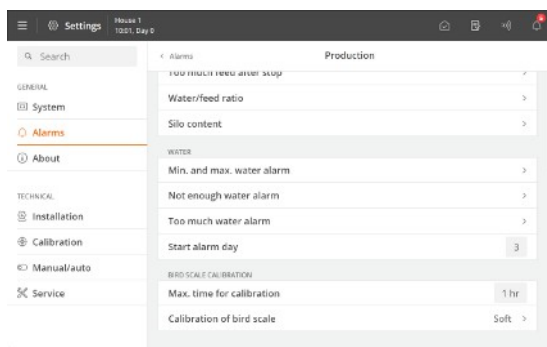

Figure 14: Example of minimum and maximum water alarm

The controller triggers an alarm when the limit for maximum water consumption is exceeded or the consumption is below the limit for minimum water consumption.



There may be various reasons for the fluctuation in the animals' water consumption that will all trigger an alarm. For example, an alarm may be triggered due to stocking more animals or the slaughter of some animals, an outbreak of disease in the livestock or a rupture of the water pipe.



### Start alarm on day

In the event of major changes to the number of animals in the house, at least 26 hours should pass before the controller can trigger the alarm.

To avoid triggering false alarms, you can indicate how many days should pass before the controller triggers a water alarm.

## 6.1.4 EggScan - egg counter

 Menu button |  Settings |  Alarms | Production | Egg

**Time before alarm - EggScan** Setting the time before alarm.

The controller triggers an alarm in the event of an error on one or more of the connected egg counters.

See also the menu **Technical | Service | Installation**.

### 6.1.4.1 Water alarms

These alarms can be disconnected automatically at batch/flock start by setting a **Start alarm day**.

   Alarms | Production | Water

**Min. and max. water alarm** The alarms are used for monitoring the animals' drinking patterns.

The alarm limits for maximum and minimum water consumption is a set percentage of the normal consumption.

The controller calculates the normal consumption by comparing the current 24-hour period with the 24-hour period that is two hours older. At 1 P.M., for example, you look at the period from 11 A.M. on the previous day to 11 A.M. on the current day.

Choose whether the water is to turn off when an alarm is generated. When all water alarms have been acknowledged, the controller turns on the water again.

#### With water control

These alarms are used for monitoring leakages and stoppages in the water system.

#### Not enough water

The alarm is triggered if the water consumption measured by a water meter is too low during a given period of time.

It is recommended to set this alarm to 1 l/min. and a monitoring time to 30 minutes. An alarm will be generated if consumption is lower than 30 liters each half hour.

<b>Too much water alarm when open</b>	<p>The alarm is triggered if the water consumption measured by a water meter is too high in a given period.</p> <p>Depending on the capacity of the water supply, the system can supply a certain quantity of water per unit of time.</p> <p>The alarm is triggered when the system has operated at maximum output for too long.</p> <p>If a water relay is installed, the water will be turned off at excessive water consumption.</p> <p><i>Guidelines for alarm limit settings:</i></p> <p>Measure the amount of water flowing per minute to the current water meter. Set the alarm limit for 1 liter less than the measured. Set the monitoring time to 30 minutes.</p>
<b>Too much water alarm when closed</b>	<p>The alarm monitors whether the water system is turned off when it should be.</p> <p>The recommended setpoint for this alarm is 1 l/min. and a monitoring period of 30 minutes.</p>
<b>Water level alarm</b>	<p>Setting the time before alarm.</p> <p>The controller does not trigger an alarm until the water level has been recorded as OFF during this time (15 min). It ensures that brief changes in the water level of the livestock house do not trigger the alarm.</p> <p>The controller does not change the regulation at the water level alarm.</p>
<b>Start alarm on day</b>	<p>Automatic disconnection at the beginning of a batch/flock. To avoid triggering false alarms, you can indicate how many days should pass before the controller triggers a water alarm.</p>

## 6.2 Master/Client alarms

If the controller is set up to share equipment with other controllers, it gives an alarm if the connection between the controllers is lost. A 'Client' controller will continue to regulate according to the latest received value from the 'Master' controller equipment until the network connection is restored.

 Menu button |  Settings |  Alarms

---

<b>Connection to Client lost</b>	Select the alarm type <b>Hard</b> , <b>Soft</b> or <b>Disabled</b> .
<b>Connection to Master lost</b>	

---

## 7 Maintenance instructions

The controller requires no maintenance to function correctly.

You should test the alarm system every week.

Use only original spare parts.

Note that the service life of the controller will be extended if it stays connected all the time, as this will keep it dry and free from condensation.

### Lock screen for cleaning

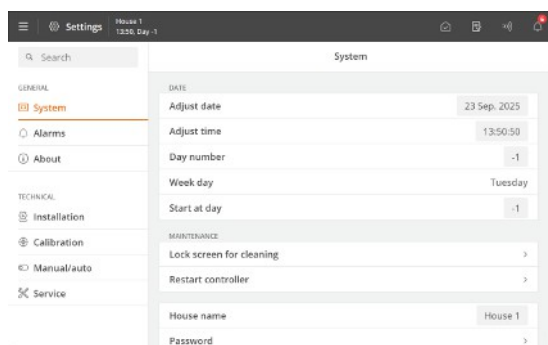

When the controller is to be cleaned, it is possible to lock the screen to avoid inadvertent operation during cleaning.

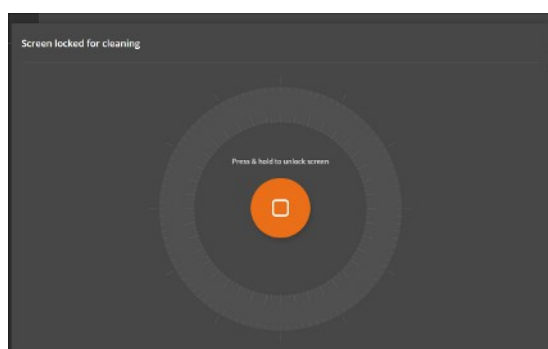

Press  Menu button |  **Settings | General | System | Maintenance | Lock screen for cleaning** to lock the screen.

Press and hold for 5 seconds to unlock the screen.

The controller automatically cancels the lock after 15 minutes.

### 7.1 Cleaning



Clean the product with a cloth that has been wrung out almost dry in water and avoid using:

- high-pressure cleaner
- solvents
- corrosive/caustic agents

We recommend to calibrate bird scales at least once per batch. See also the Technical Manual.

### 7.2 Recycling/Disposal



The label indicates that the product must not be disposed of as general refuse disposal and must be treated as electronic waste.



The label indicates that the product is suitable for recycling.

It must be possible for customers to deliver the products to local collection sites/recycling stations in accordance with local instructions. The recycling station will then arrange for further transport to a certified plant for reuse, recovery and recycling.





Big Dutchman International GmbH • Calveslage • Auf der lage 2 • 49377 Vechta; Germany  
Tel. +49(0)4447/801-0 • Fax +49(0)4447/801-237 • [big@bigdutchman.com](mailto:big@bigdutchman.com)

